

YCRSCR 32 CONSOLIDATED

Yoke type track roller

TYPE: Roller bearings, Yoke type track rollers, With axial guidance, Double row roller set, contact seals on both side, inch size

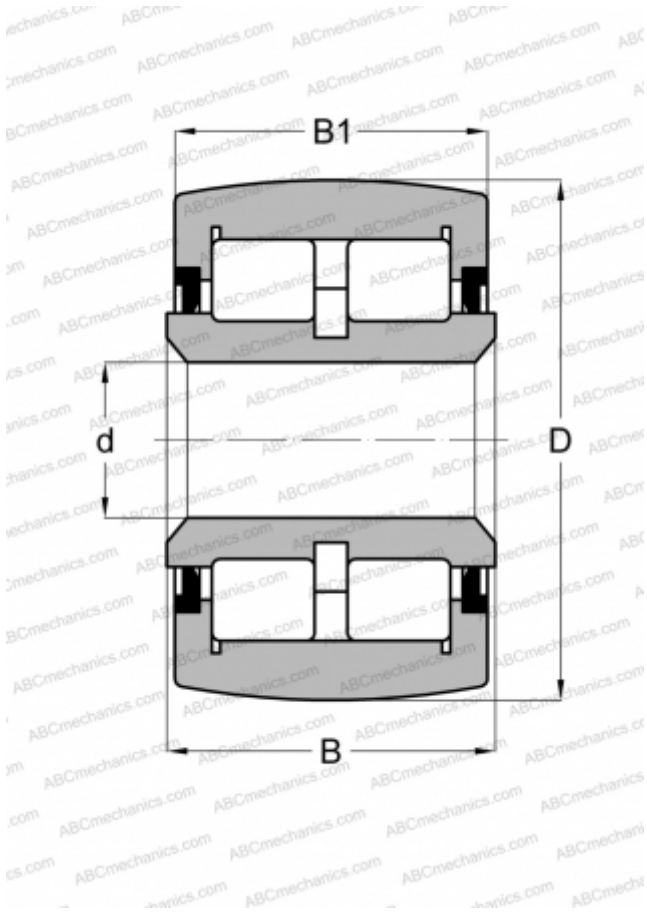

Technical specification

DIMENSIONS, MM

d	15,875
D	50,800
B	33,325
B1	31,750

WEIGHT, KG

0,417

MANUFACTURER

[CONSOLIDATED](#)

INTERCHANGE

ABC

[CRBY 2](#)