

CRBY 4 ABC

Yoke type track roller

TYPE: Roller bearings, Yoke type track rollers, With axial guidance, Double row roller set, contact seals on both side, inch size

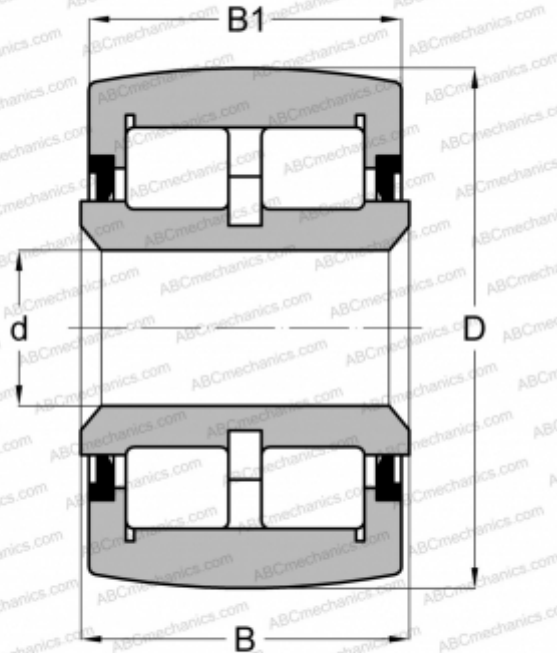

Technical specification

DIMENSIONS, MM

d	31,750
D	101,600
B	58,725
B1	57,150

WEIGHT, KG

3,016

MANUFACTURER

[ABC](#)

INTERCHANGE

CONSOLIDATED

[YCRSCR 64](#)