

CRBY 5 ABC

Yoke type track roller

TYPE: Roller bearings, Yoke type track rollers, With axial guidance, Double row roller set, contact seals on both side, inch size

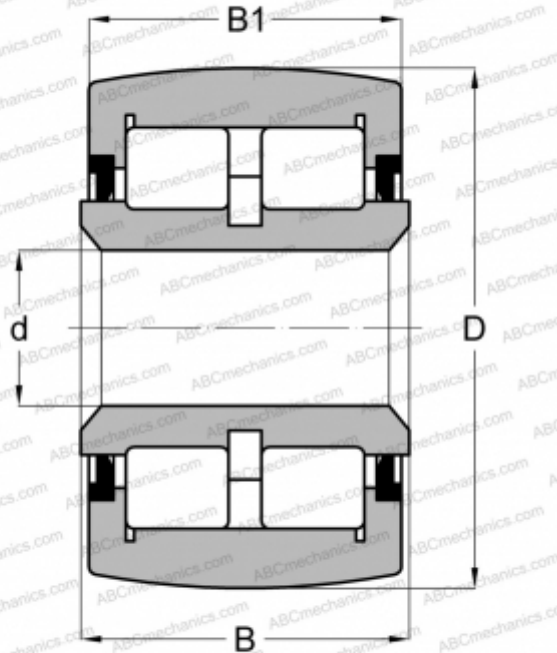

Technical specification

DIMENSIONS, MM

d	44,704
D	127,000
B	73,025
B1	69,850

WEIGHT, KG

5,579

MANUFACTURER

[ABC](#)

INTERCHANGE

CONSOLIDATED

[YCRSCR 80](#)