

CRBY 6 ABC

Yoke type track roller

TYPE: Roller bearings, Yoke type track rollers, With axial guidance, Double row roller set, contact seals on both side, inch size

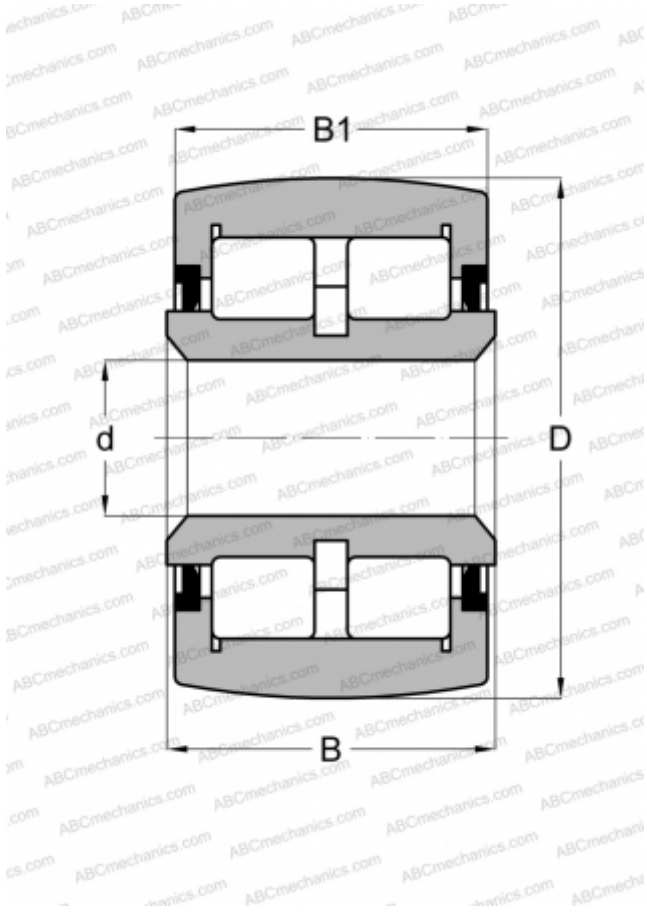

Technical specification

DIMENSIONS, MM

d	57,150
D	152,400
B	85,725
B1	82,550

WEIGHT, KG

9,344

MANUFACTURER

[ABC](#)

INTERCHANGE

CONSOLIDATED

[YCRSCR 96](#)