

CF 18 PP INA

Cam followers

TYPE: Roller bearings, Stud type track rollers, Hex socket, contact seals on both side, cylindrical outer ring, inch size

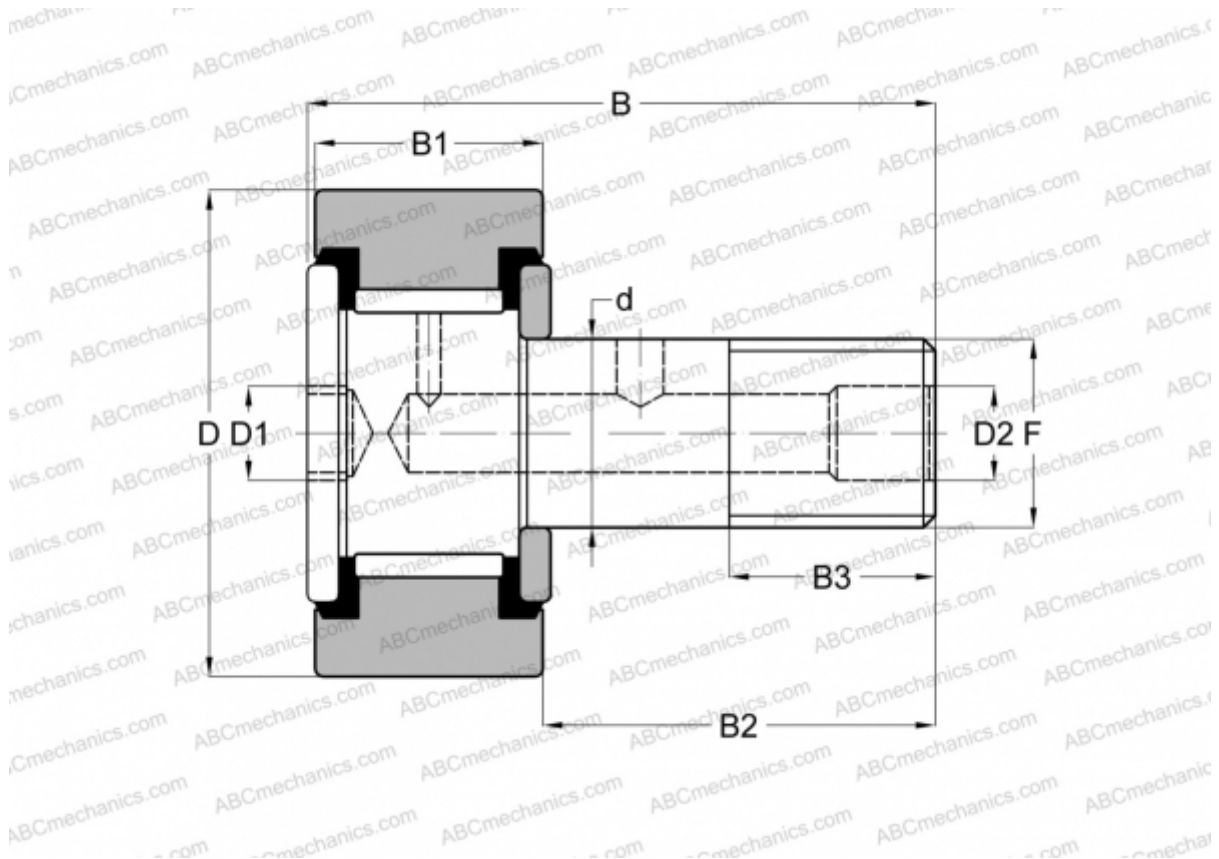

Technical specification

DIMENSIONS, MM

d	11,113
D	28,575
D1	6,350
D2	4,763
B	42,068
B1	15,875
B2	25,400
B3	12,700
F	7/16-20

WEIGHT, KG 0,086

MANUFACTURER [INA](#)

INTERCHANGE

ABC [CRSB 18](#)

INTERCHANGE

McGill	CF-1 1/8 -SB
RBC	S 36 LW
SMITH BEARING	CR-1 1/8 -XB
TORRINGTON	CRSB 18