

CF 26 PP INA

Cam followers

TYPE: Roller bearings, Stud type track rollers, Hex socket, contact seals on both side, cylindrical outer ring, inch size

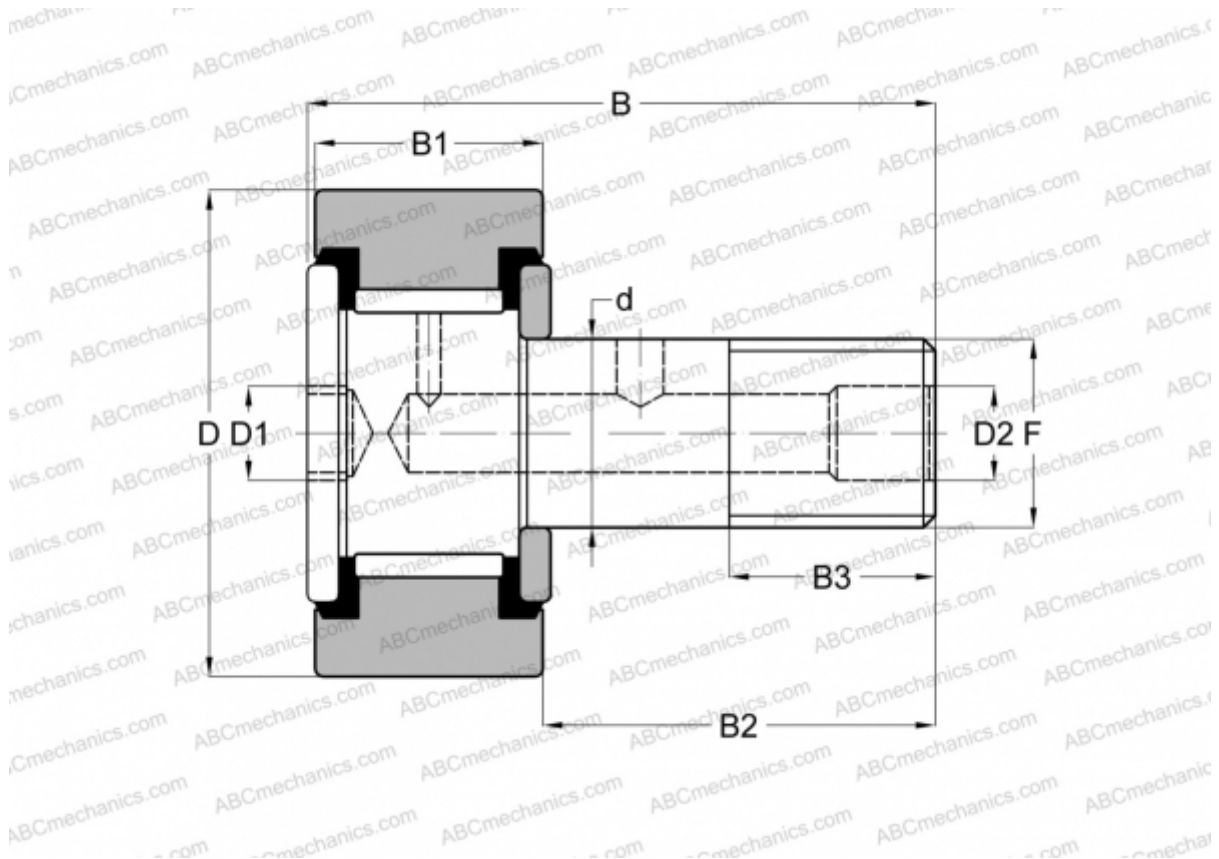

Technical specification

DIMENSIONS, MM

d	15,875
D	41,275
D1	7,938
D2	4,763
B	61,118
B1	22,225
B2	38,100
B3	19,050
F	5/8-18

WEIGHT, KG 0,272

MANUFACTURER [INA](#)

INTERCHANGE

ABC [CRSB 26](#)

INTERCHANGE

McGill	CF-1 5/8 -SB
RBC	S 52 LW
SMITH BEARING	CR-1 5/8 -XB
TORRINGTON	CRSB 26