

CF-1 3/4 -SB McGill

Cam followers

TYPE: Roller bearings, Stud type track rollers, Hex socket, contact seals on both side, cylindrical outer ring, inch size

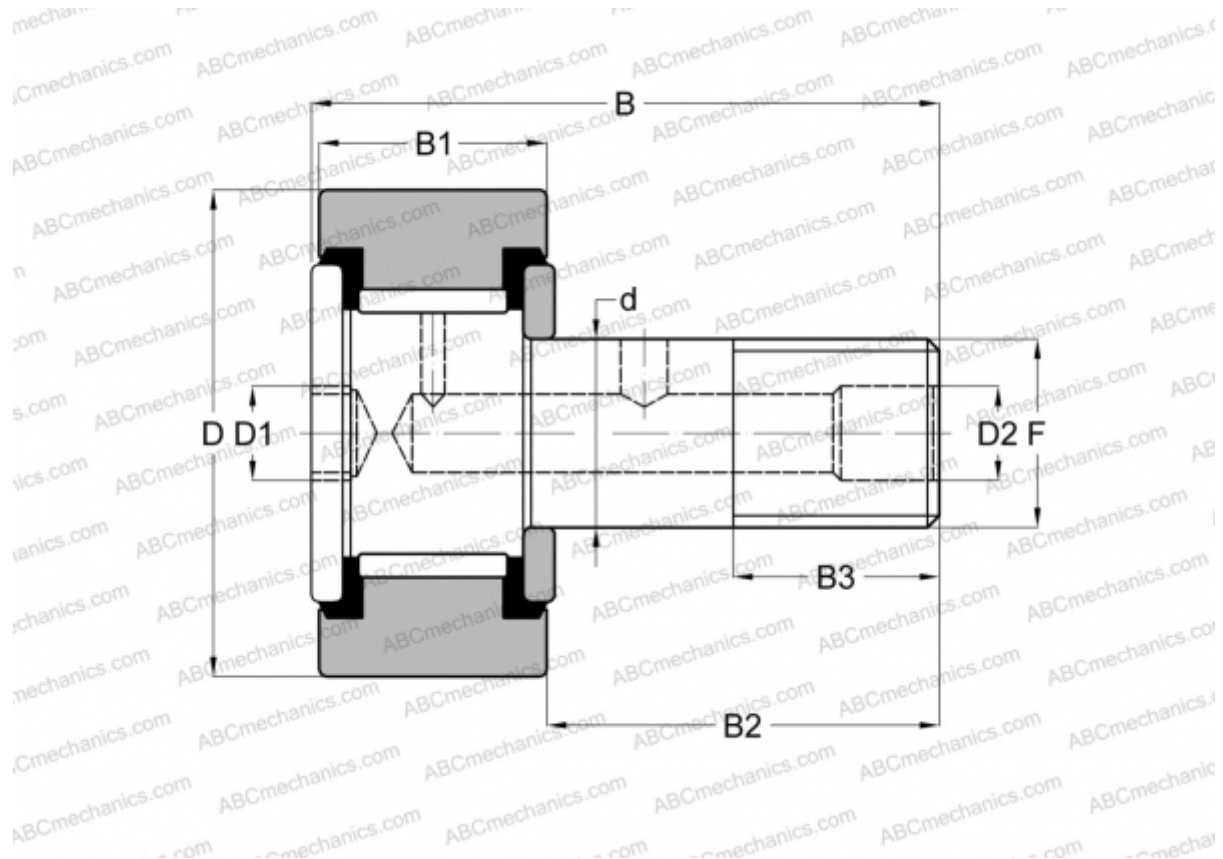

Technical specification

DIMENSIONS, MM

d	19,050
D	44,450
D1	7,938
D2	4,763
B	70,643
B1	25,400
B2	44,450
B3	22,225
F	3/4-16

WEIGHT, KG 0,376

MANUFACTURER [McGill](#)

INTERCHANGE

ABC [CRSB 28](#)

INTERCHANGE

INA	CF 28 PP
RBC	S 56 LW
SMITH BEARING	CR-1 3/4 -XB
TORRINGTON	CRSB 28