

CR-1 7/8 -XB SMITH BEARING

Cam followers

TYPE: Roller bearings, Stud type track rollers, Hex socket, contact seals on both side, cylindrical outer ring, inch size

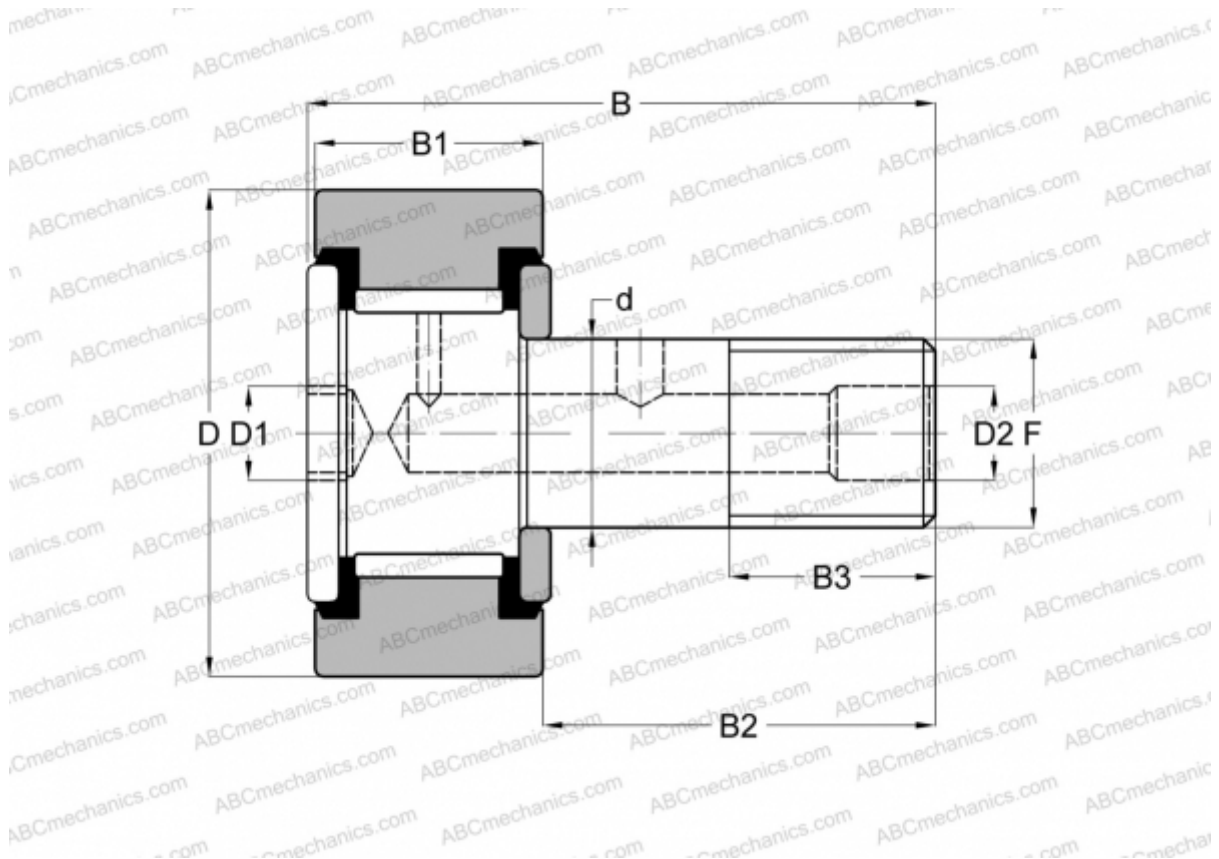

Technical specification

DIMENSIONS, MM

d	19,050
D	47,625
D1	7,938
D2	4,763
B	70,643
B1	25,400
B2	44,450
B3	22,225
F	3/4-16

WEIGHT, KG 0,417

MANUFACTURER [SMITH BEARING](#)

INTERCHANGE

ABC [CRSB 30](#)

INTERCHANGE

INA	CF 30 PP
McGill	CF-1 7/8 -SB
RBC	S 60 LW
TORRINGTON	CRSB 30