

CRSBC 14 ABC

Cam followers

TYPE: Roller bearings, Stud type track rollers, Hex socket, contact seals on both side, inch size

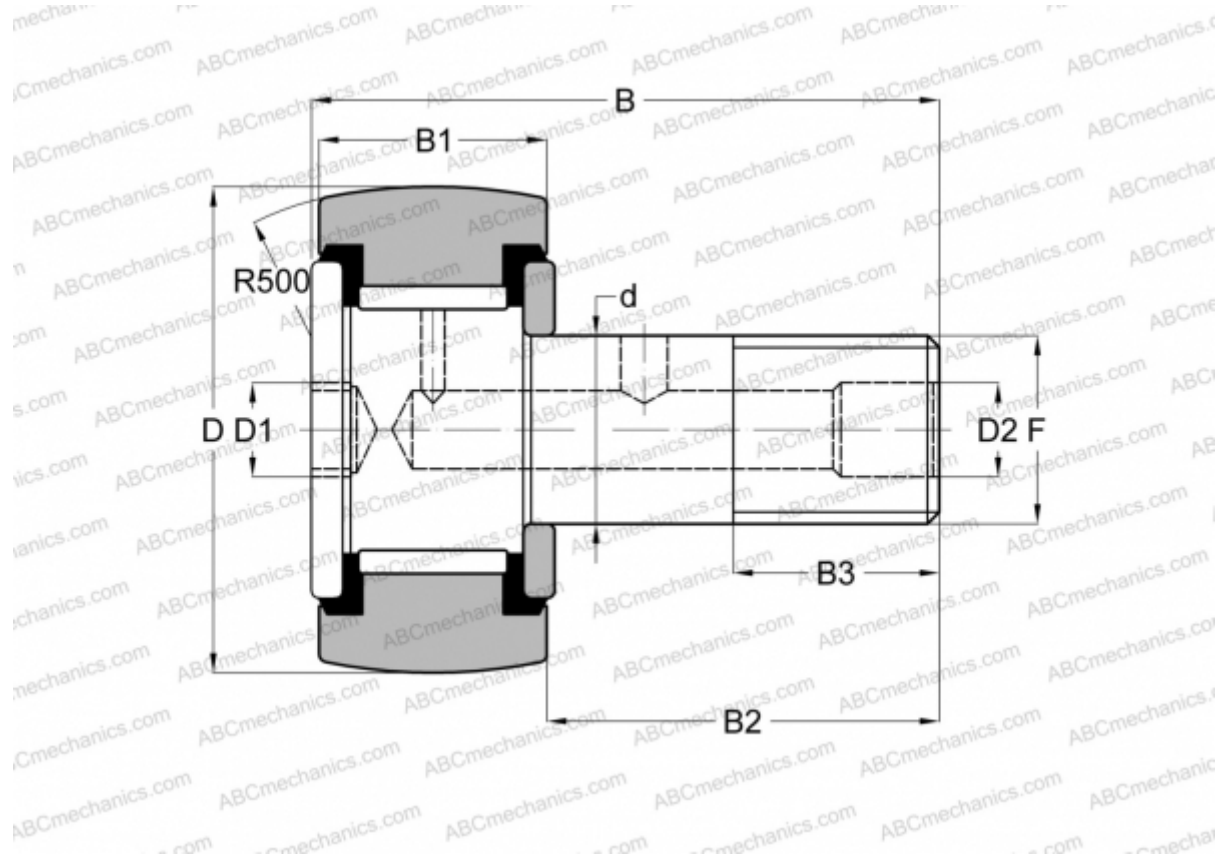

Technical specification

DIMENSIONS, MM

d	9,525
D	22,225
D1	4,763
D2	4,763
B	35,718
B1	12,700
B2	22,225
B3	9,525
F	3/8-24

WEIGHT, KG 0,045

MANUFACTURER [ABC](#)

INTERCHANGE

INA [CF 14 PPY](#)

INTERCHANGE

McGill	CCF- 7/8 -SB
RBC	CS 28 LW
SMITH BEARING	CR- 7/8 -XBC
TORRINGTON	CRSBC 14