

CF 22 PPY INA

Cam followers

TYPE: Roller bearings, Stud type track rollers, Hex socket, contact seals on both side, inch size

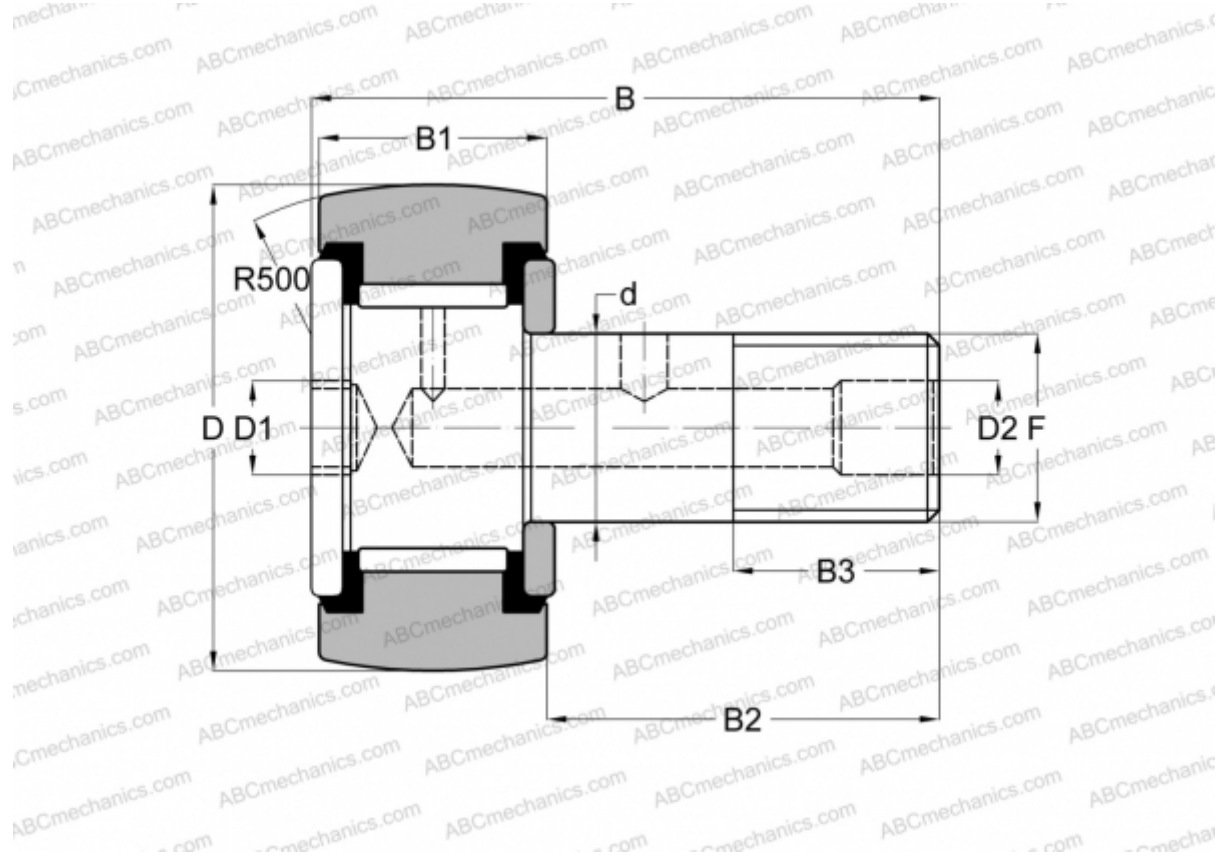

Technical specification

DIMENSIONS, MM

d	12,700
D	34,925
D1	6,350
D2	4,763
B	51,593
B1	19,050
B2	31,750
B3	15,875
F	1/2-20

WEIGHT, KG 0,159

MANUFACTURER [INA](#)

INTERCHANGE

ABC [CRSBC 22](#)

INTERCHANGE

McGill	CCF-1 3/8 -SB
RBC	CS 44 LW
SMITH BEARING	CR-1 3/8 -XBC
TORRINGTON	CRSBC 22