

CRSBC 24 ABC

Cam followers

TYPE: Roller bearings, Stud type track rollers, Hex socket, contact seals on both side, inch size

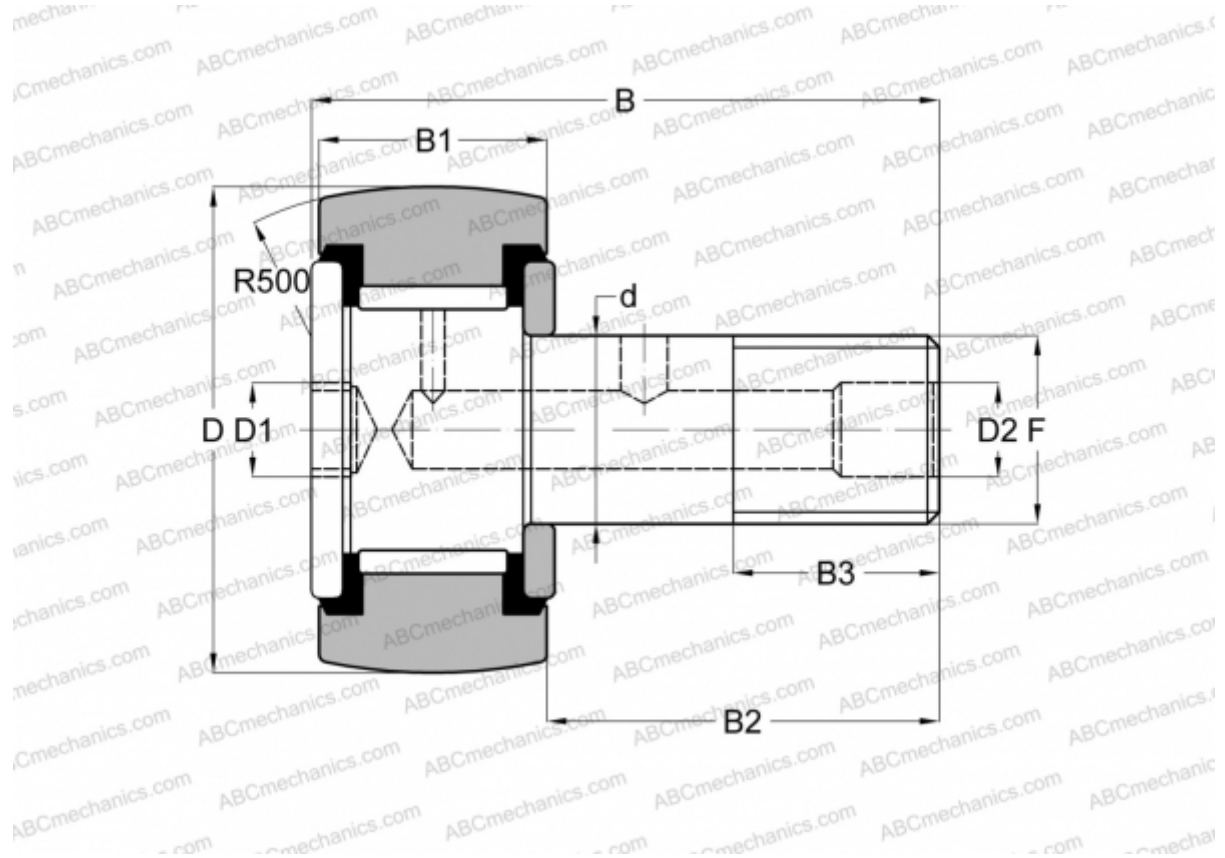

Technical specification

DIMENSIONS, MM

d	15,875
D	38,100
D1	7,938
D2	4,763
B	61,118
B1	22,225
B2	38,100
B3	19,050
F	5/8-18

WEIGHT, KG 0,236

MANUFACTURER [ABC](#)

INTERCHANGE

INA [CF 24 PPY](#)

INTERCHANGE

McGill	CCF-1 1/2 -SB
RBC	CS 48 LW
SMITH BEARING	CR-1 1/2 -XBC
TORRINGTON	CRSBC 24