

CR-1 1/8 -XBCE SMITH BEARING

Cam followers

TYPE: Roller bearings, Stud type track rollers, Eccentric stud, hex socket, contact seals on both side, inch size

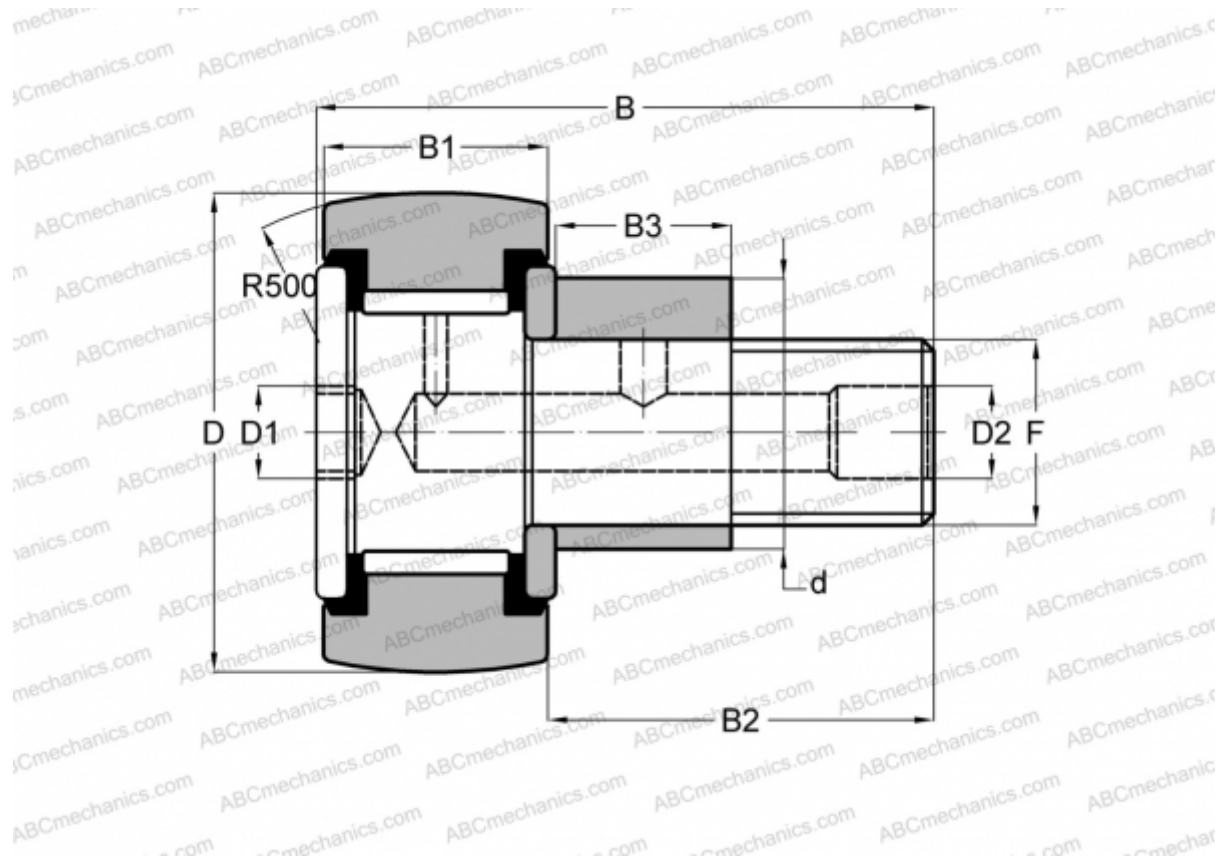

Technical specification

DIMENSIONS, MM

d	15,875
D	28,575
D1	6,350
D2	4,763
B	42,068
B1	15,875
B2	25,400
B3	12,700
T	12,700
F	7/16-20

WEIGHT, KG 0,095

MANUFACTURER [SMITH BEARING](#)

INTERCHANGE

TORRINGTON	CRSBCE 18
INA	CFE 18 PPY
McGill	CCFE-1 1/8 -SB
RBC	CS 36 LWX