

CFE 20 PPY INA

Cam followers

TYPE: Roller bearings, Stud type track rollers, Eccentric stud, hex socket, contact seals on both side, inch size

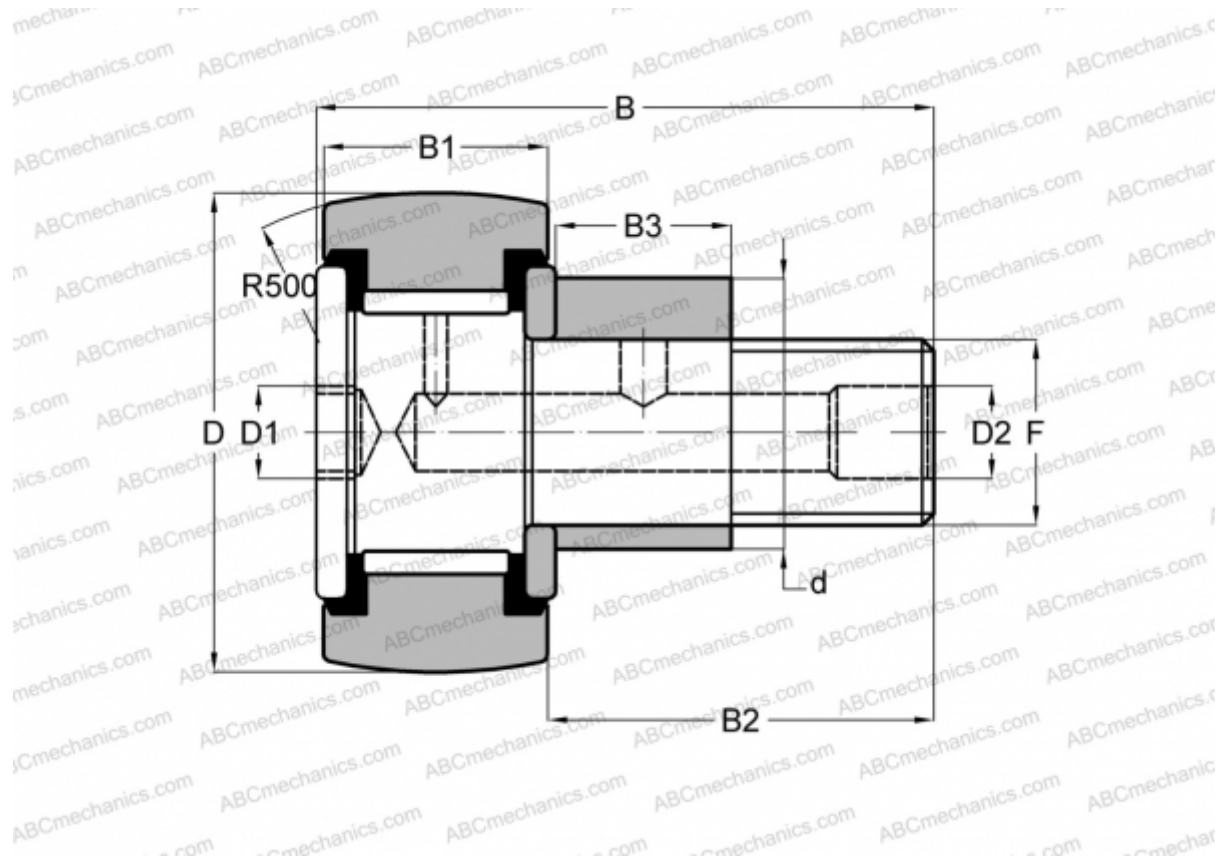

Technical specification

DIMENSIONS, MM

d	17,463
D	31,750
D1	6,350
D2	4,763
B	51,593
B1	19,050
B2	31,750
B3	15,875
T	15,875
F	1/2 -20

WEIGHT, KG 0,150

MANUFACTURER [INA](#)

INTERCHANGE

TORRINGTON	CRSBCE 20
McGill	CCFE-1 1/4 -SB
RBC	CS 40 LWX
SMITH BEARING	CR-1 1/4 -XBCE