

CRSBCE 22 TORRINGTON

Cam followers

TYPE: Roller bearings, Stud type track rollers, Eccentric stud, hex socket, contact seals on both side, inch size

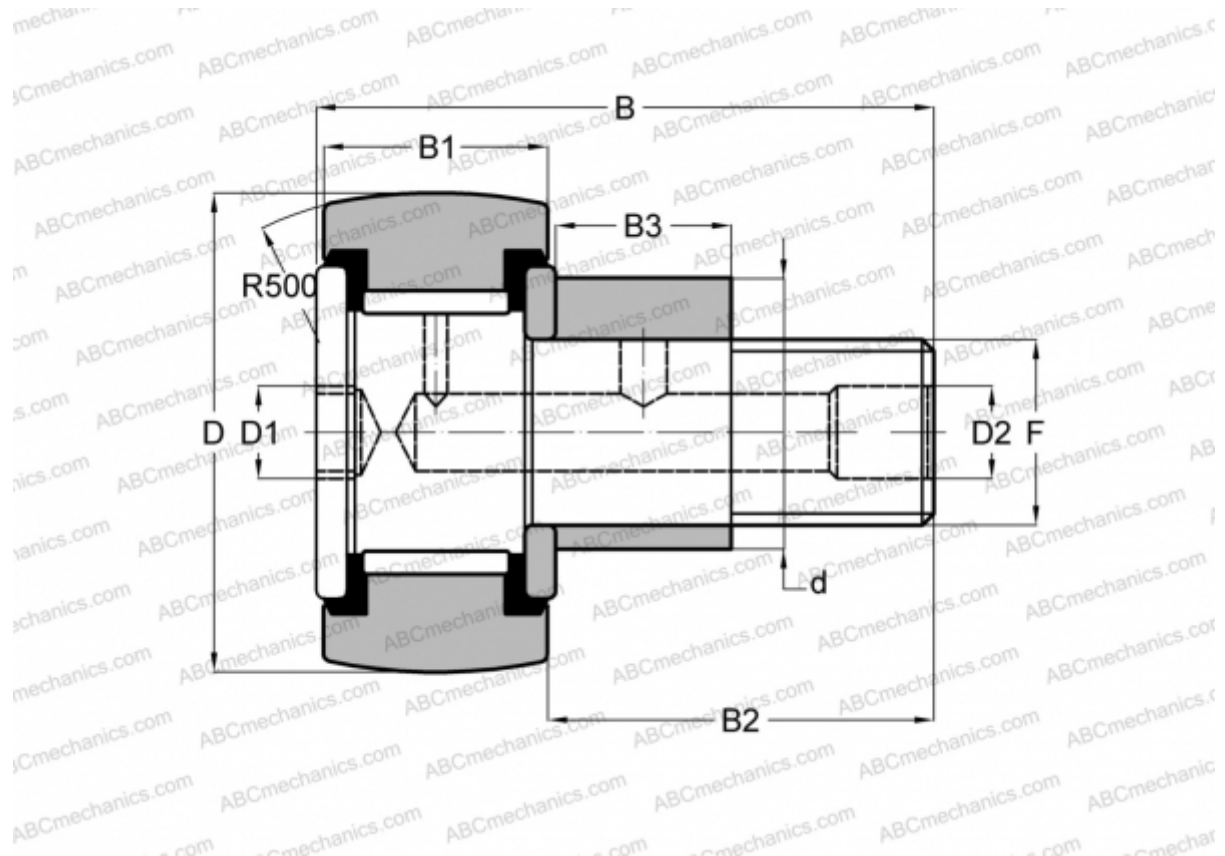

Technical specification

DIMENSIONS, MM

d	17,463
D	34,925
D1	6,350
D2	4,763
B	51,593
B1	19,050
B2	31,750
B3	15,875
T	15,875
F	1/2 -20

WEIGHT, KG 0,172

MANUFACTURER [TORRINGTON](#)

INTERCHANGE

INA	CFE 22 PPY
McGill	CCFE-1 3/8 -SB
RBC	CS 44 LWX
SMITH BEARING	CR-1 3/8 -XBCE