

## CCFE-1 1/2 -SB McGill

Cam followers

TYPE: Roller bearings, Stud type track rollers, Eccentric stud, hex socket, contact seals on both side, inch size

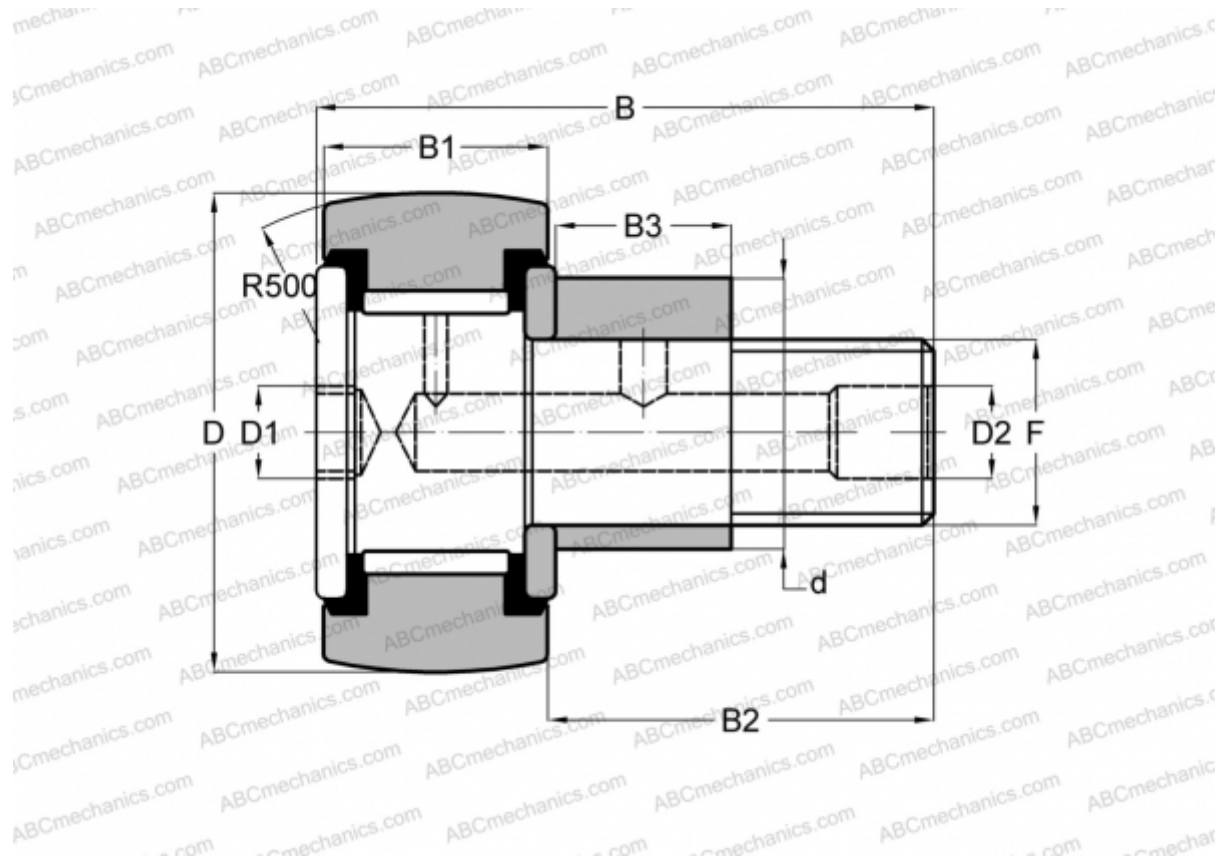

### Technical specification

#### DIMENSIONS, MM

d	22,225
D	38,100
D1	7,938
D2	4,763
B	61,118
B1	22,225
B2	38,100
B3	19,050
T	19,050
F	5/8-18

**WEIGHT, KG** 0,263

**MANUFACTURER** [McGill](#)

#### INTERCHANGE

TORRINGTON	<a href="#">CRSBCE 24</a>
INA	<a href="#">CFE 24 PPY</a>
RBC	<a href="#">CS 48 LWX</a>
SMITH BEARING	<a href="#">CR-1 1/2 -XBCE</a>