

CCFE-1 5/8 -SB McGill

Cam followers

TYPE: Roller bearings, Stud type track rollers, Eccentric stud, hex socket, contact seals on both side, inch size

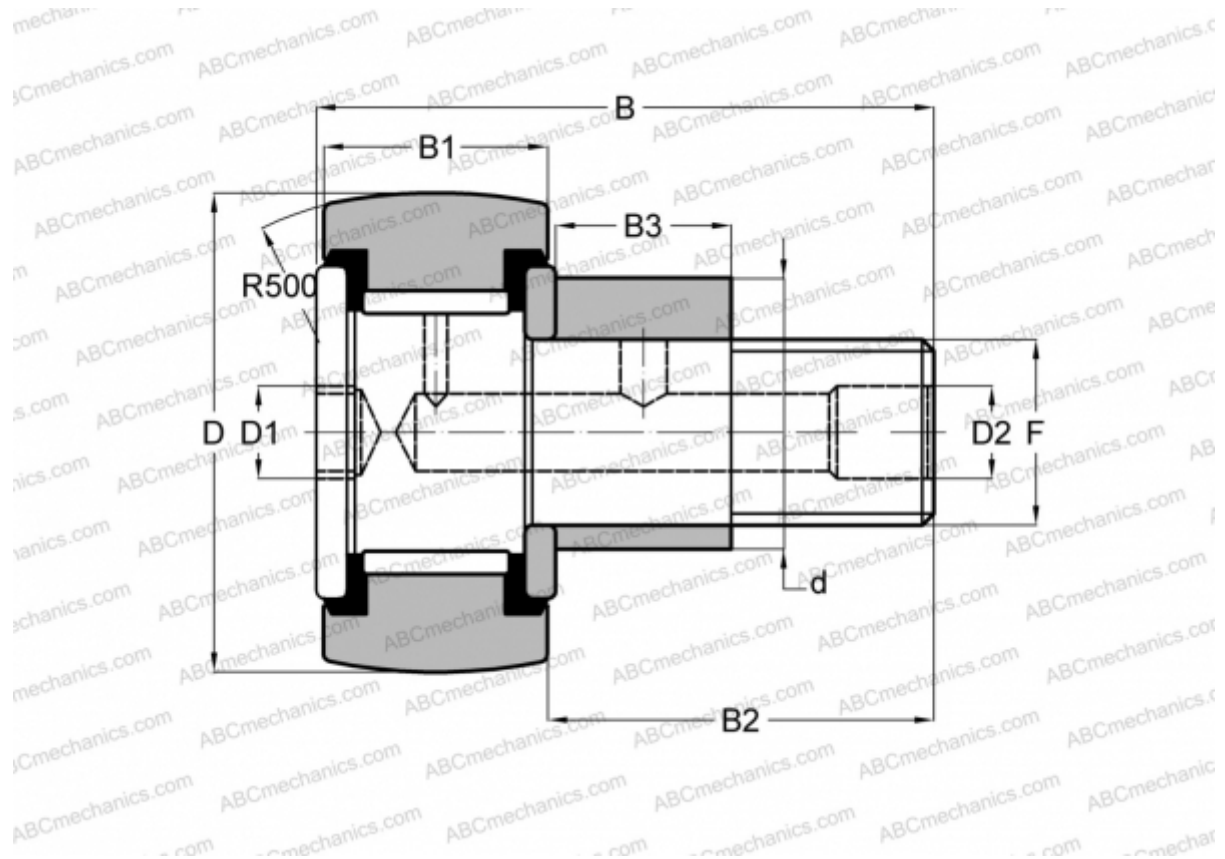

Technical specification

DIMENSIONS, MM

d	22,225
D	41,275
D1	7,938
D2	4,763
B	61,118
B1	22,225
B2	38,100
B3	19,050
T	19,050
F	5/8-18

WEIGHT, KG 0,295

MANUFACTURER [McGill](#)

INTERCHANGE

TORRINGTON	CRSBCE 26
INA	CFE 26 PPY
RBC	CS 52 LWX
SMITH BEARING	CR-1 5/8 -XBCE