

CFE 28 PPY INA

Cam followers

TYPE: Roller bearings, Stud type track rollers, Eccentric stud, hex socket, contact seals on both side, inch size

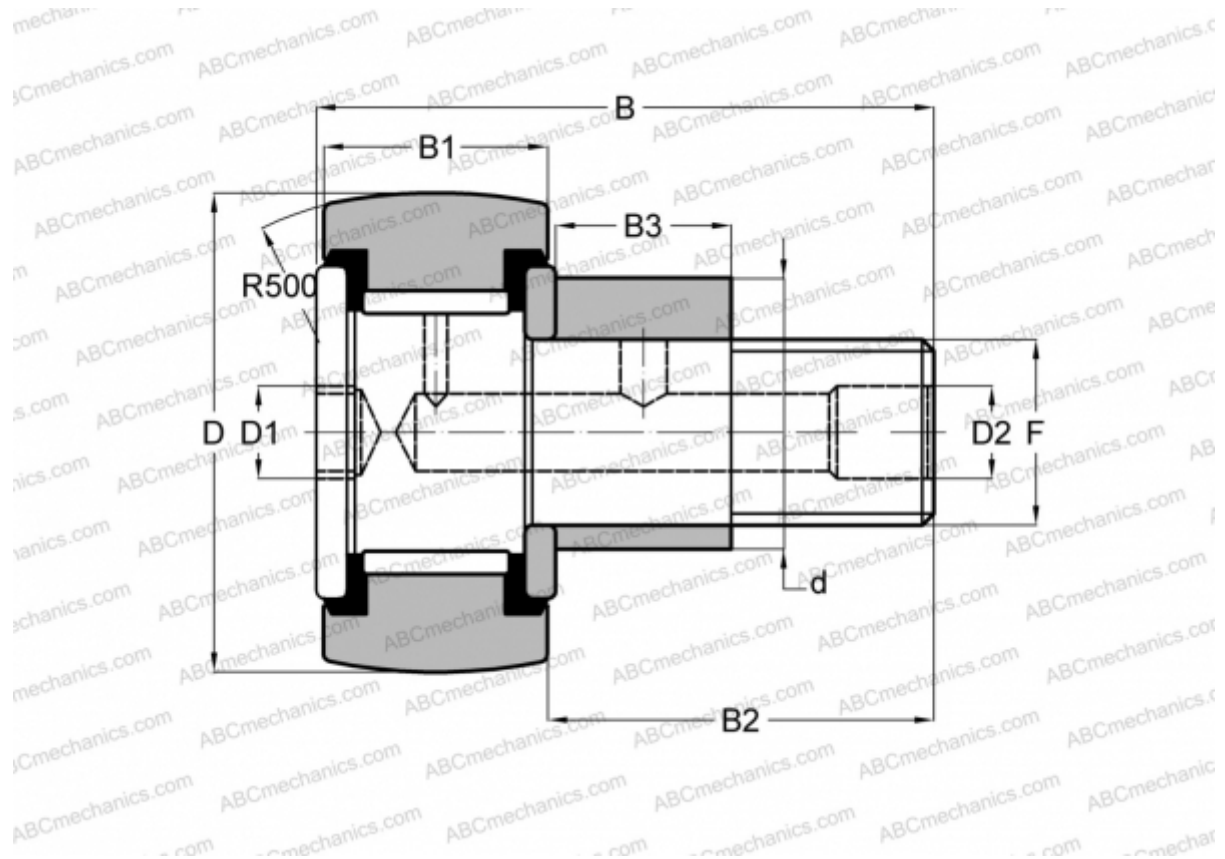

Technical specification

DIMENSIONS, MM

d	25,400
D	44,450
D1	7,938
D2	4,763
B	70,643
B1	25,400
B2	44,450
B3	22,225
T	22,225
F	3/4-16

WEIGHT, KG 0,408

MANUFACTURER [INA](#)

INTERCHANGE

TORRINGTON	CRSBCE 28
McGill	CCFE-1 3/4 -SB
RBC	CS 56 LWX
SMITH BEARING	CR-1 3/4 -XBCE