

CFE 32 PPY INA

Cam followers

TYPE: Roller bearings, Stud type track rollers, Eccentric stud, hex socket, contact seals on both side, inch size

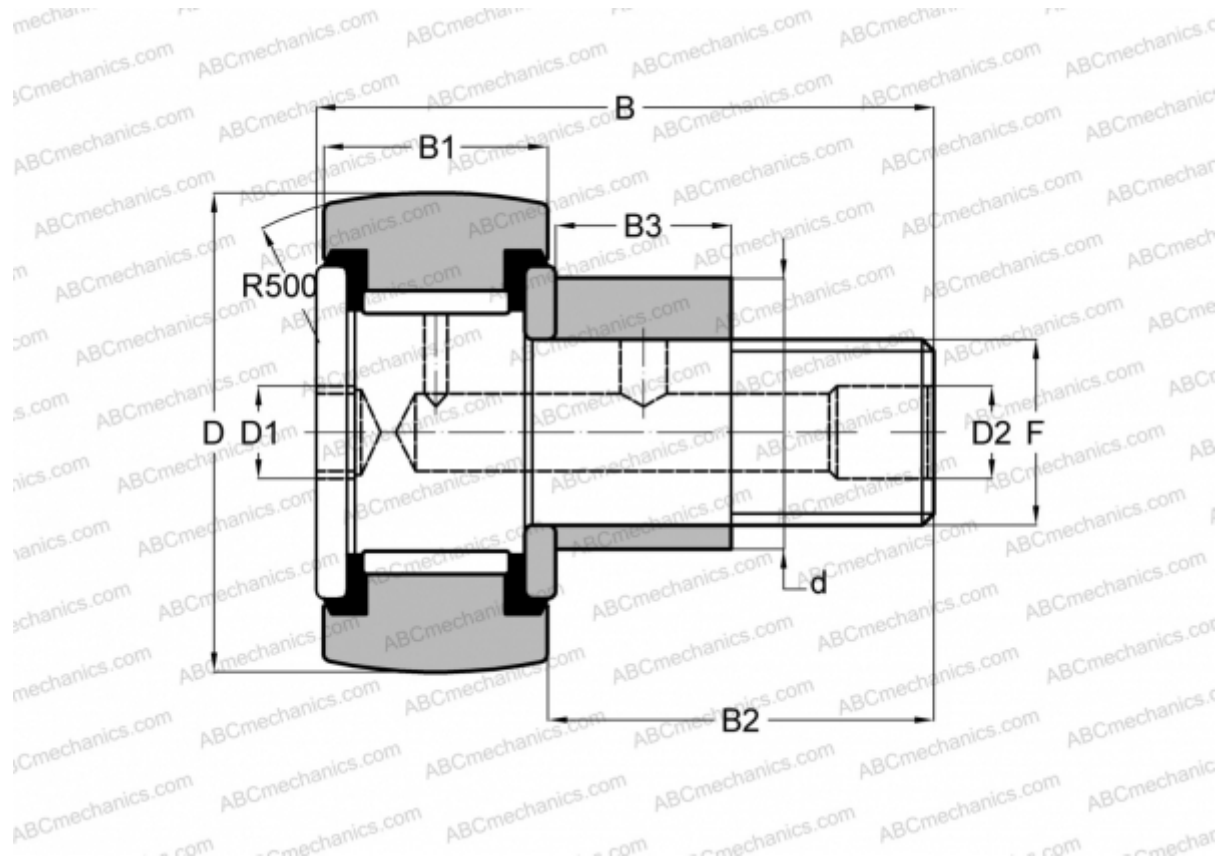

Technical specification

DIMENSIONS, MM

d	30,163
D	50,800
D1	7,938
D2	4,763
B	83,343
B1	31,750
B2	50,800
B3	25,400
T	25,400
F	7/8-14

WEIGHT, KG 0,635

MANUFACTURER [INA](#)

INTERCHANGE

TORRINGTON	CRSBCE 32
McGill	CCFE-2-SB
RBC	CS 64 LWX
SMITH BEARING	CR-2-XBCE