

CFE 36 PPY INA

Cam followers

TYPE: Roller bearings, Stud type track rollers, Eccentric stud, hex socket, contact seals on both side, inch size

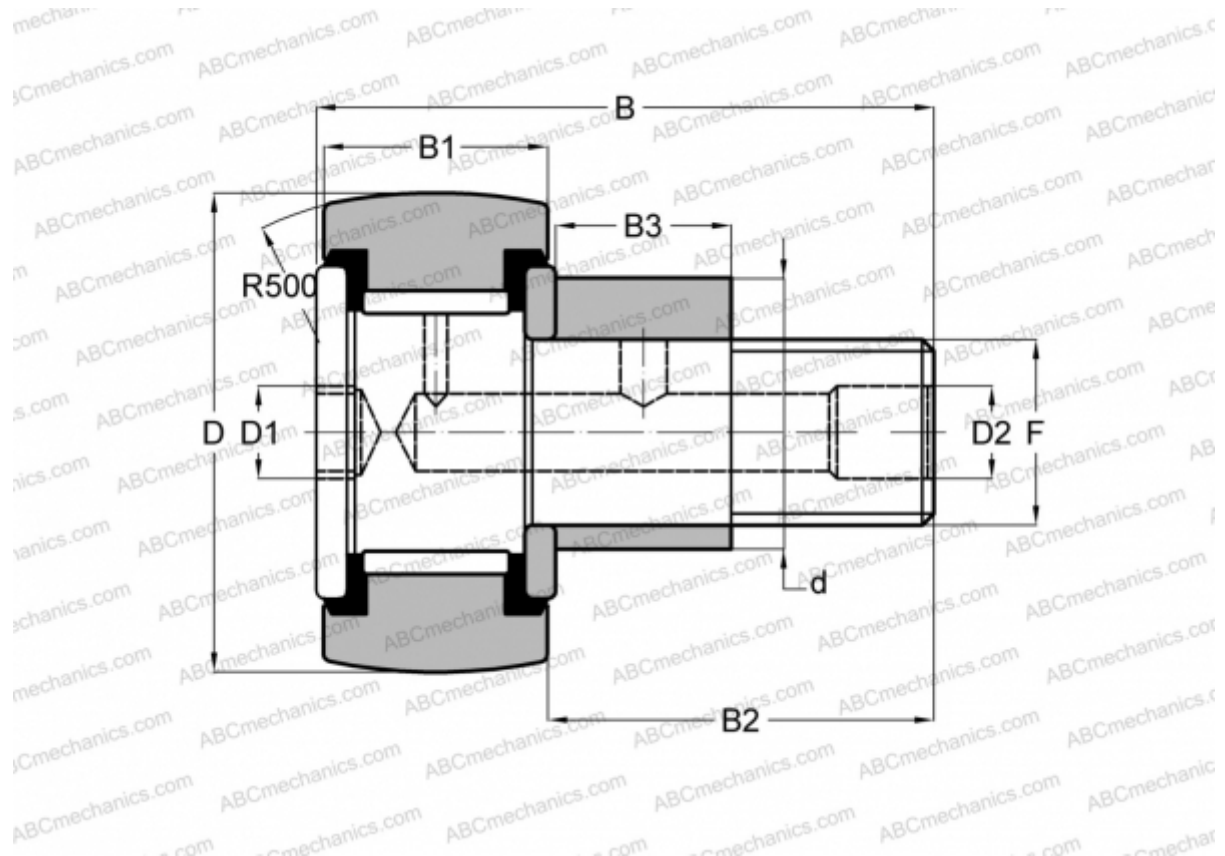

Technical specification

DIMENSIONS, MM

d	30,163
D	57,150
D1	7,938
D2	4,763
B	83,343
B1	31,750
B2	50,800
B3	25,400
T	25,400
F	7/8-14

WEIGHT, KG 0,771

MANUFACTURER [INA](#)

INTERCHANGE

TORRINGTON	CRSBCE 36
McGill	CCFE-2 1/4 -SB
RBC	CS 72 LWX
SMITH BEARING	CR-2 1/4 -XBCE