

HR 1/2 XB SMITH BEARING

Cam followers

TYPE: Roller bearings, Stud type track rollers, Heavy duty stud, hex socket, contact seals on both side, cylindrical outer ring, inch size

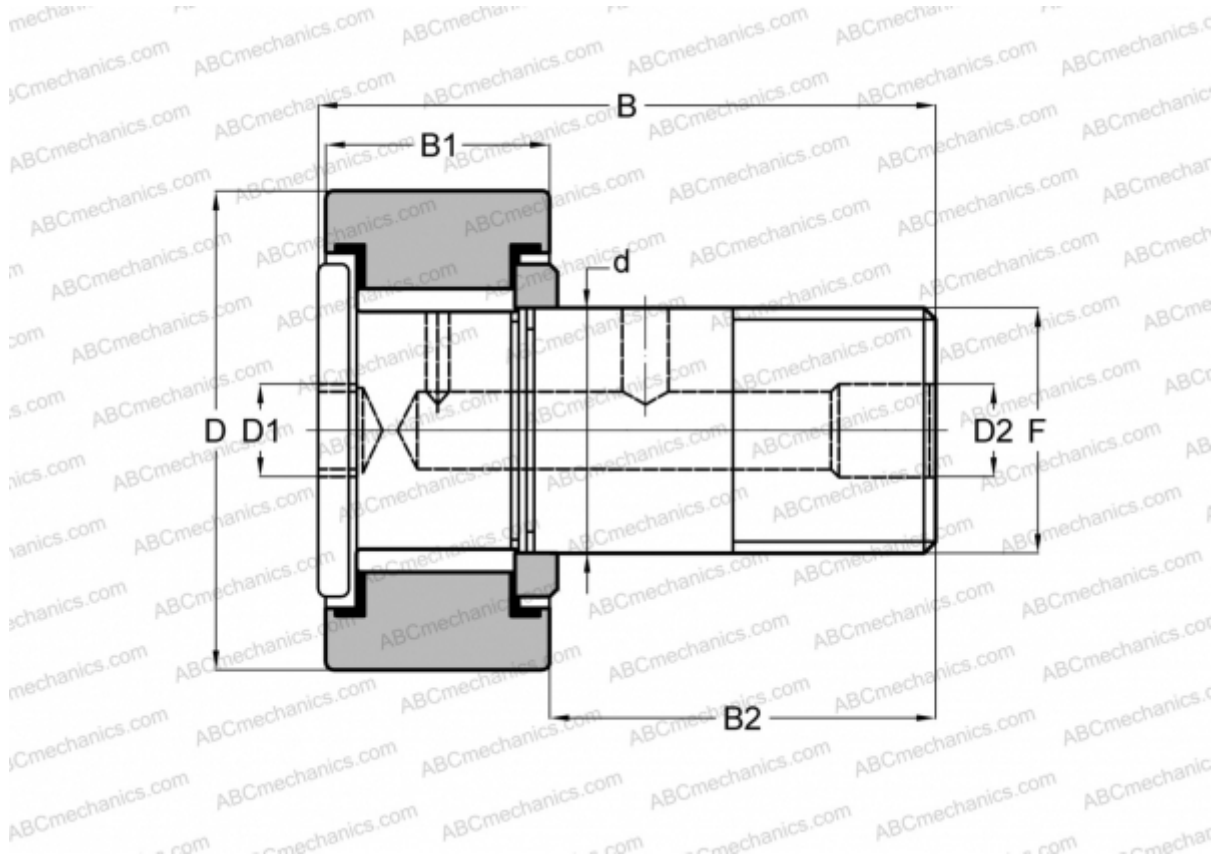

Technical specification

DIMENSIONS, MM

d	6,350
D	12,700
D1	3,175
B	26,193
B1	9,525
B2	15,875
F	1/4 -28

WEIGHT, KG 0,014

MANUFACTURER [SMITH BEARING](#)

INTERCHANGE

TORRINGTON	CRHSB 8-1
McGill	CFH 1/2 SB
RBC	H 16 LW