

H 20 LW RBC

Cam followers

TYPE: Roller bearings, Stud type track rollers, Heavy duty stud, hex socket, contact seals on both side, cylindrical outer ring, inch size

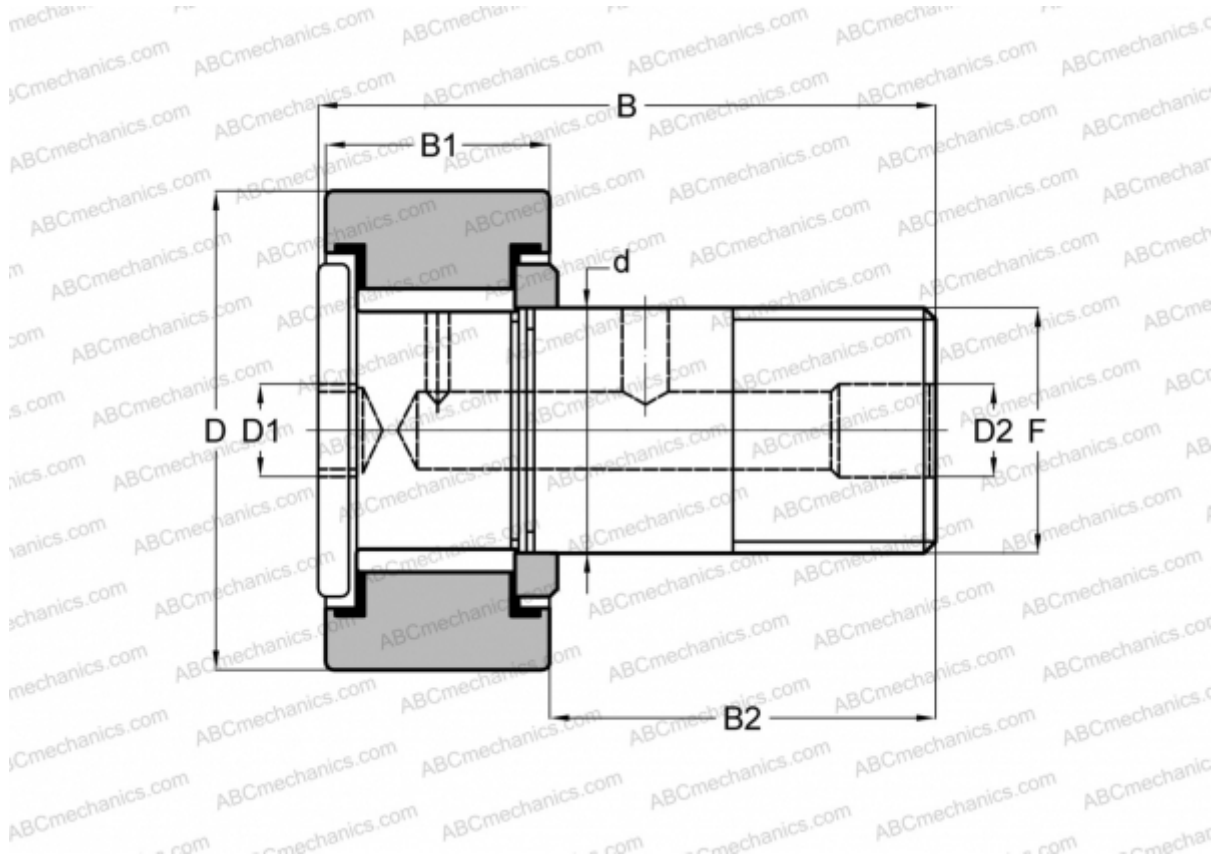

Technical specification

DIMENSIONS, MM

d	7,938
D	15,875
D1	3,175
B	30,955
B1	11,113
B2	19,050
F	5/16-24

WEIGHT, KG 0,027

MANUFACTURER [RBC](#)

INTERCHANGE

TORRINGTON	CRHSB 10-1
McGill	CFH 5/8 SB
SMITH BEARING	HR 5/8 XB