

HR 1 3/8 XB SMITH BEARING

Cam followers

TYPE: Roller bearings, Stud type track rollers, Heavy duty stud, hex socket, contact seals on both side, cylindrical outer ring, inch size

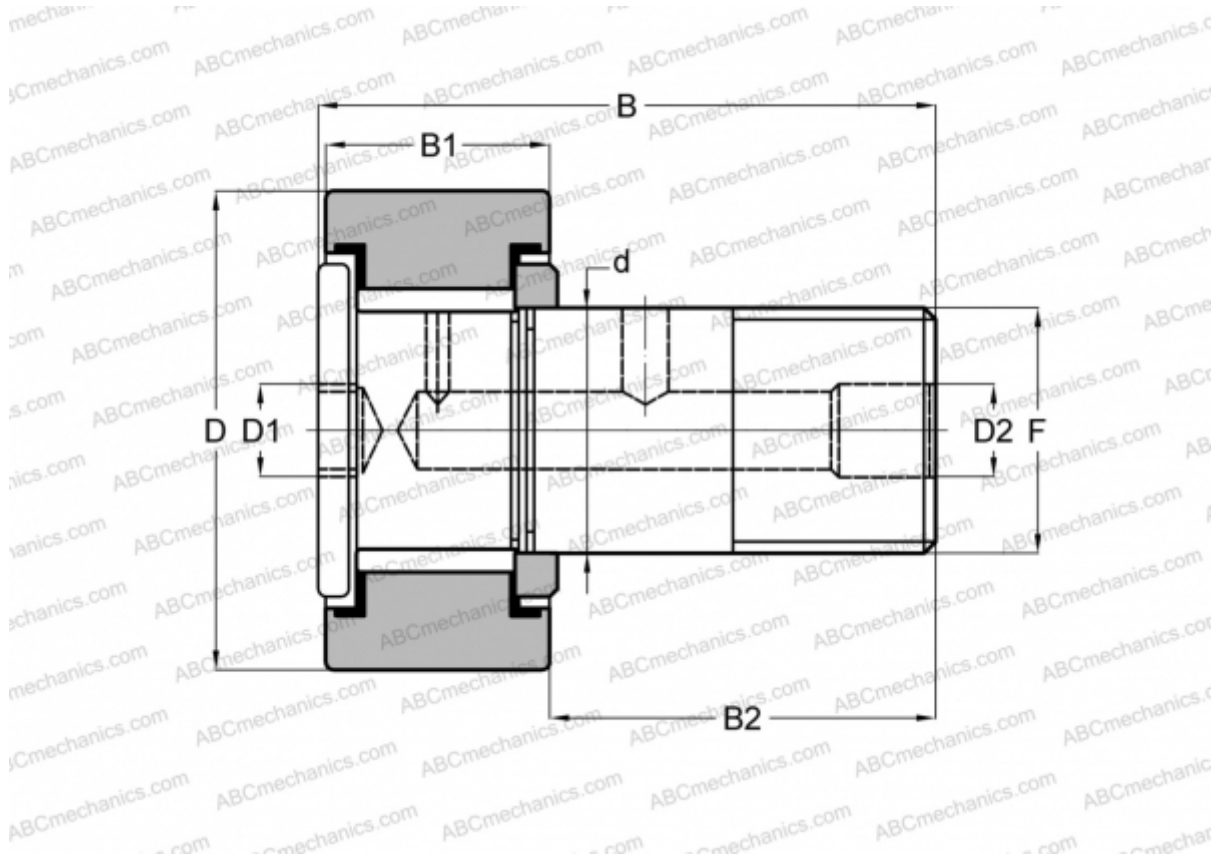

Technical specification

DIMENSIONS, MM

d	19,050
D	34,925
D1	6,350
D2	4,763
B	51,593
B1	19,050
B2	31,750
F	3/4-16

INTERCHANGE

RBC	H 44 LW
-----	-------------------------

WEIGHT, KG 0,200

MANUFACTURER [SMITH BEARING](#)

INTERCHANGE
 TORRINGTON [CRHSB 22](#)
 McGill [CFH 1 3/8 SB](#)