

H 60 LW RBC

Cam followers

TYPE: Roller bearings, Stud type track rollers, Heavy duty stud, hex socket, contact seals on both side, cylindrical outer ring, inch size

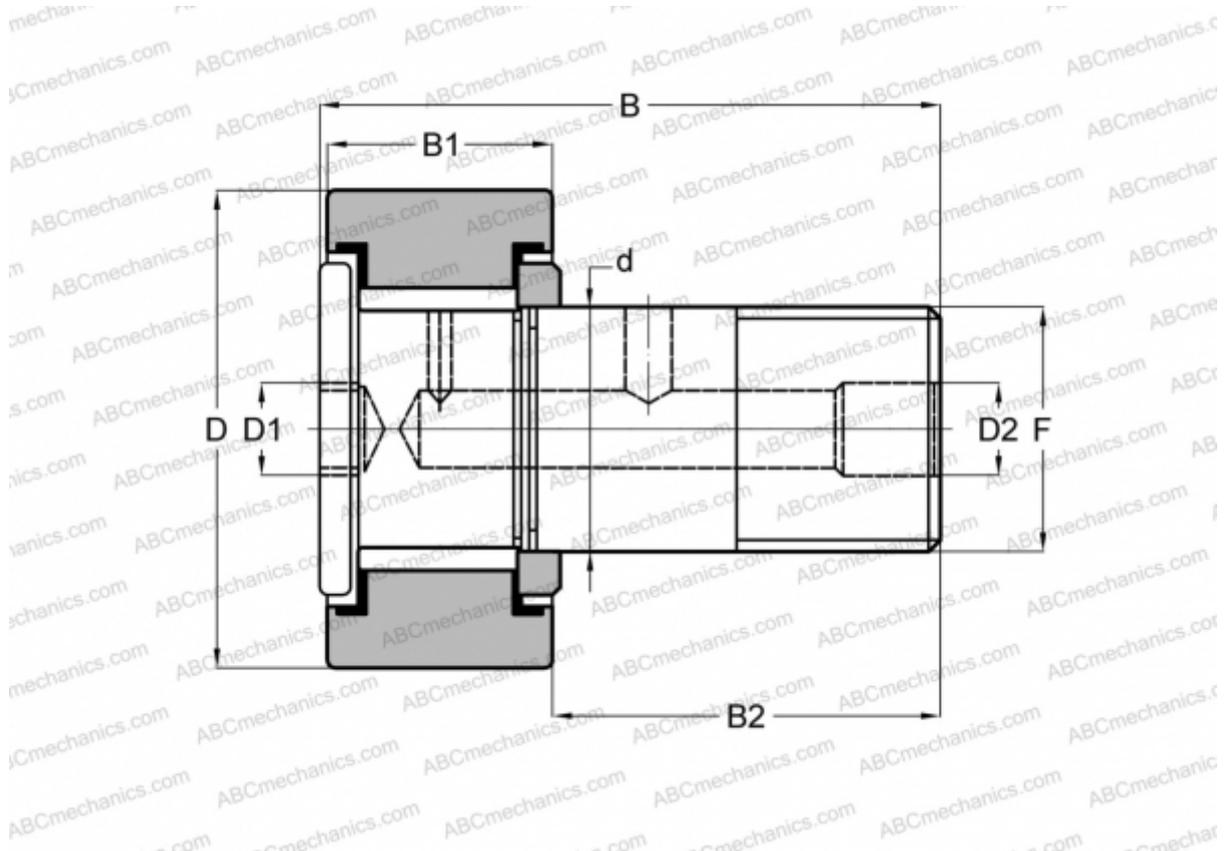

Technical specification

DIMENSIONS, MM

d	25,400
D	47,625
D1	7,938
D2	4,763
B	70,643
B1	25,400
B2	44,450
F	1-14

INTERCHANGE

SMITH BEARING

[HR 1 7/8 XB](#)

WEIGHT, KG

0,508

MANUFACTURER

[RBC](#)

INTERCHANGE

TORRINGTON

[CRHSB 30](#)

McGill

[CFH 1 7/8 SB](#)