

CFH 2 SB McGill

Cam followers

TYPE: Roller bearings, Stud type track rollers, Heavy duty stud, hex socket, contact seals on both side, cylindrical outer ring, inch size

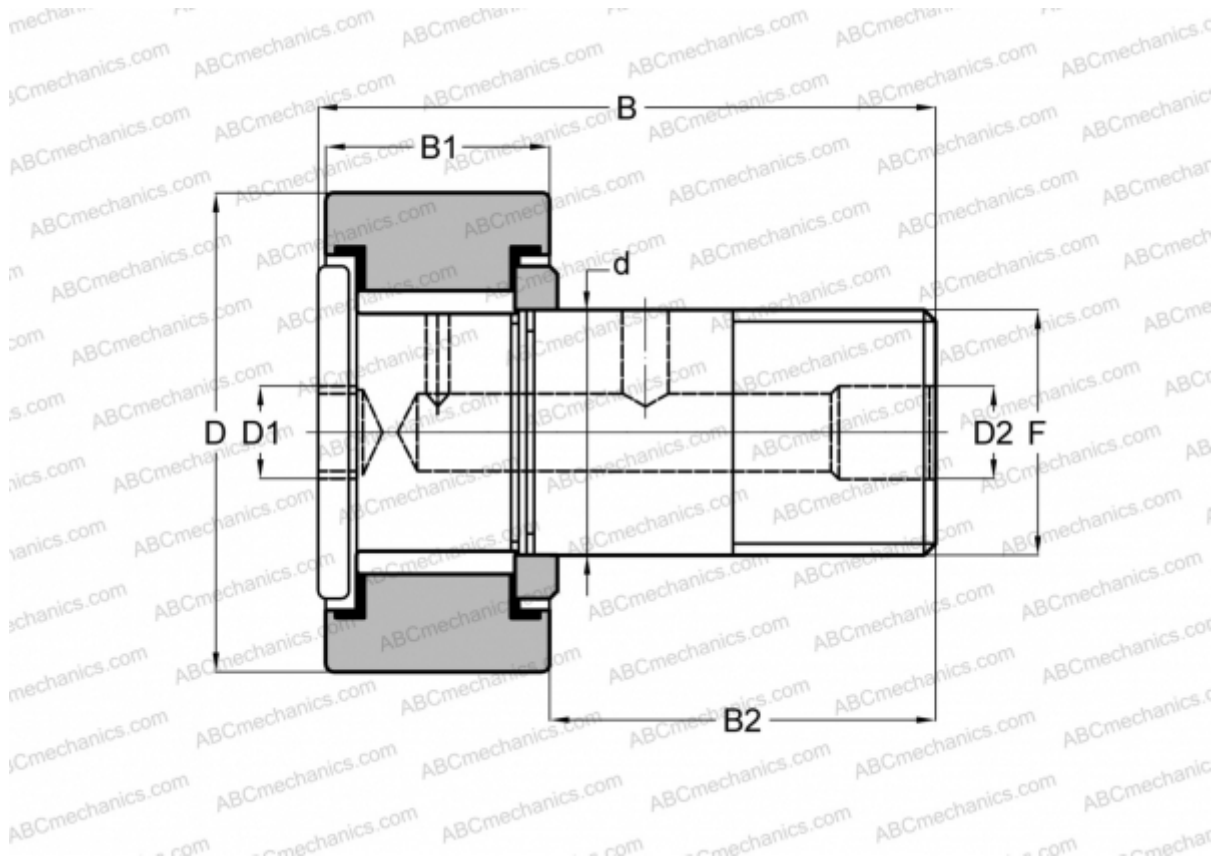

Technical specification

DIMENSIONS, MM

d	28,575
D	50,800
D1	11,113
D2	4,763
B	83,343
B1	31,750
B2	50,800
F	1 1/8-12

INTERCHANGE

SMITH BEARING

[HR 2 XB](#)

WEIGHT, KG

0,721

MANUFACTURER

[McGill](#)

INTERCHANGE

TORRINGTON

[CRHSB 32](#)

RBC

[H 64 LW](#)