

CRHSB 48 TORRINGTON

Cam followers

TYPE: Roller bearings, Stud type track rollers, Heavy duty stud, hex socket, contact seals on both side, cylindrical outer ring, inch size

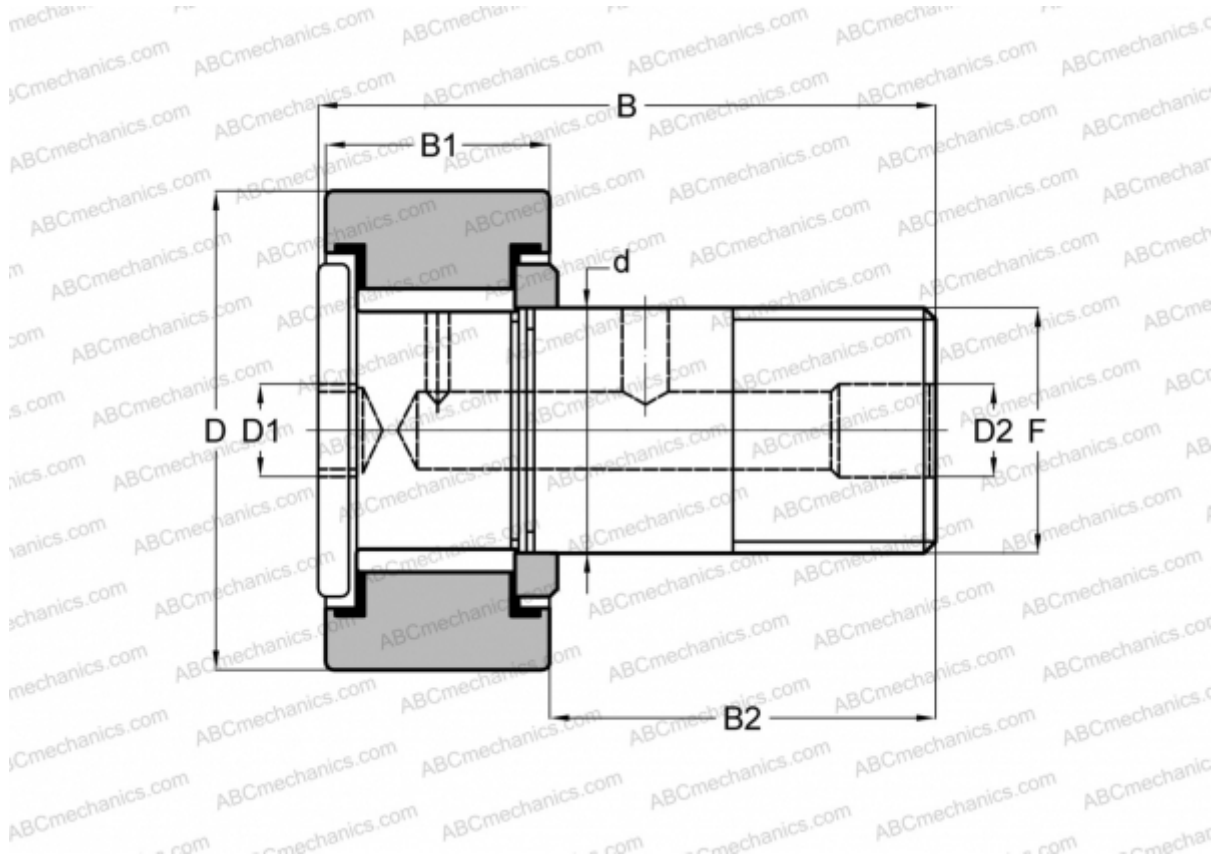

Technical specification

DIMENSIONS, MM

d	38,100
D	76,200
D1	15,875
D2	6,350
B	108,742
B1	44,450
B2	63,500
F	1 1/2-12

INTERCHANGE

SMITH BEARING

[HR 3 XB](#)

WEIGHT, KG

2,068

MANUFACTURER

[TORRINGTON](#)

INTERCHANGE

McGill	CFH 3 SB
RBC	H 96 LW