

CH 28 LW RBC

Cam followers

TYPE: Roller bearings, Stud type track rollers, Heavy duty stud, hex socket, contact seals on both side, inch size

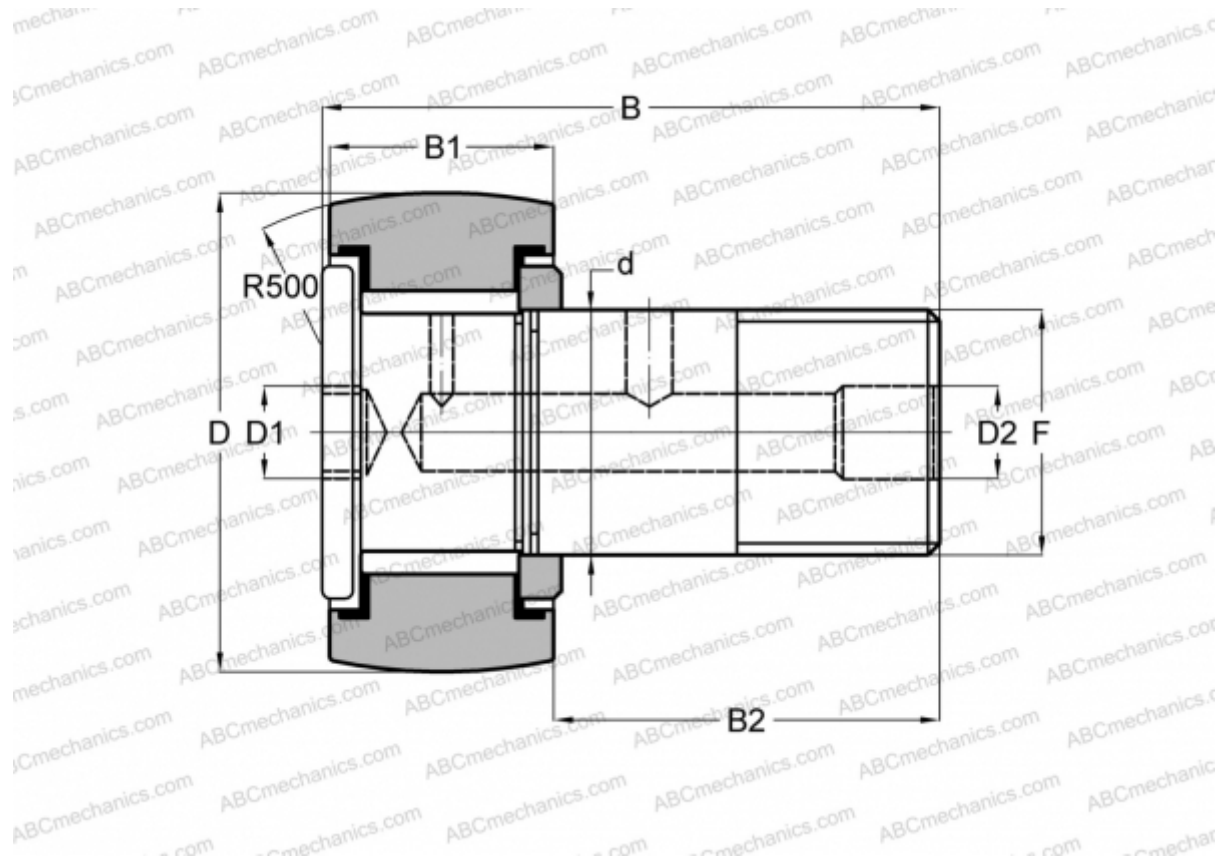

Technical specification

DIMENSIONS, MM

d	11,100
D	22,225
D1	4,763
D2	4,763
B	35,718
B1	12,700
B2	22,225
F	7/16-20

INTERCHANGE

SMITH BEARING

[HR 7/8 XBC](#)

WEIGHT, KG

0,050

MANUFACTURER

[RBC](#)

INTERCHANGE

TORRINGTON

[CRHSBC 14](#)

McGill

[CCFH 7/8 SB](#)