

CCFH 1 1/2 SB McGill

Cam followers

TYPE: Roller bearings, Stud type track rollers, Heavy duty stud, hex socket, contact seals on both side, inch size

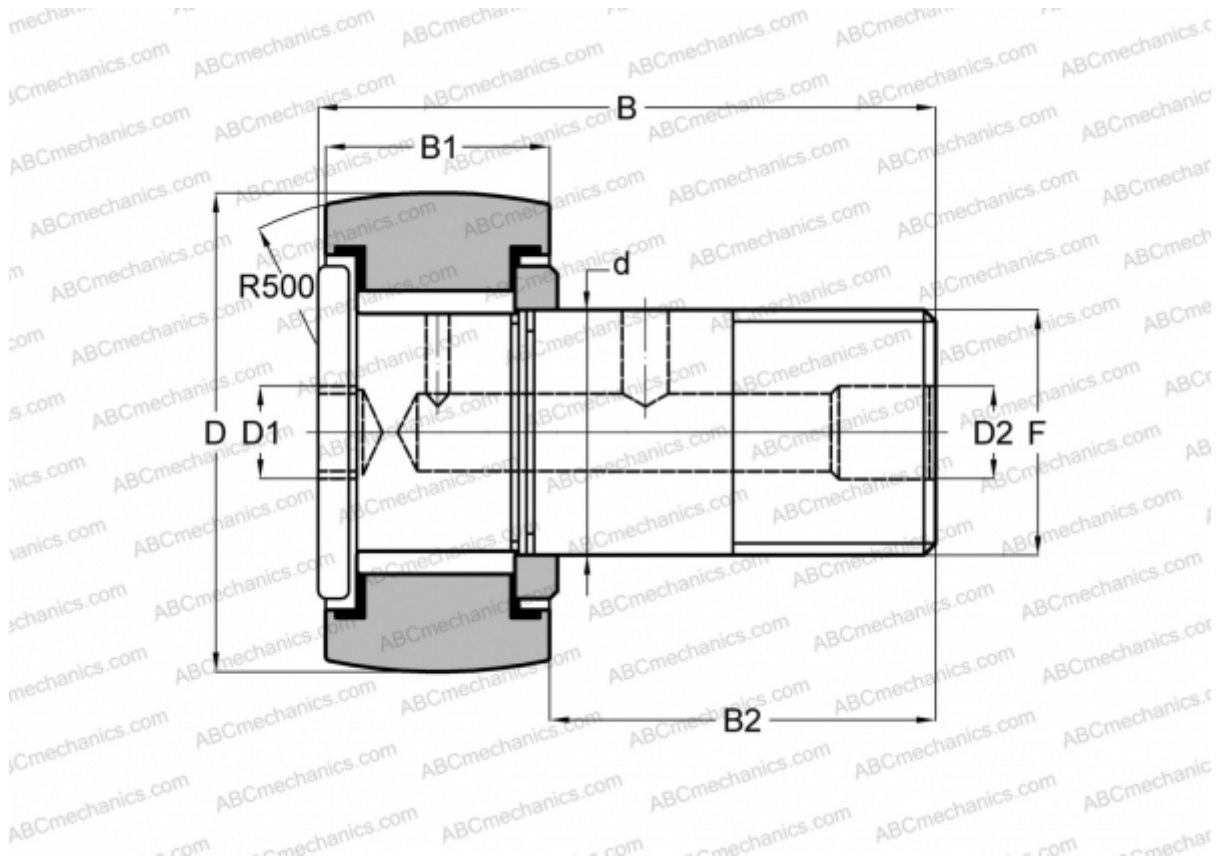

Technical specification

DIMENSIONS, MM

d	22,225
D	38,100
D1	7,938
D2	4,763
B	61,118
B1	22,225
B2	38,100
F	7/8-14

WEIGHT, KG 0,299

MANUFACTURER [McGill](#)

INTERCHANGE

TORRINGTON	CRHSBC 24
RBC	CH 48 LW

INTERCHANGE

SMITH BEARING [HR 1 1/2 XBC](#)