

CRHSBC 28 TORRINGTON

Cam followers

TYPE: Roller bearings, Stud type track rollers, Heavy duty stud, hex socket, contact seals on both side, inch size

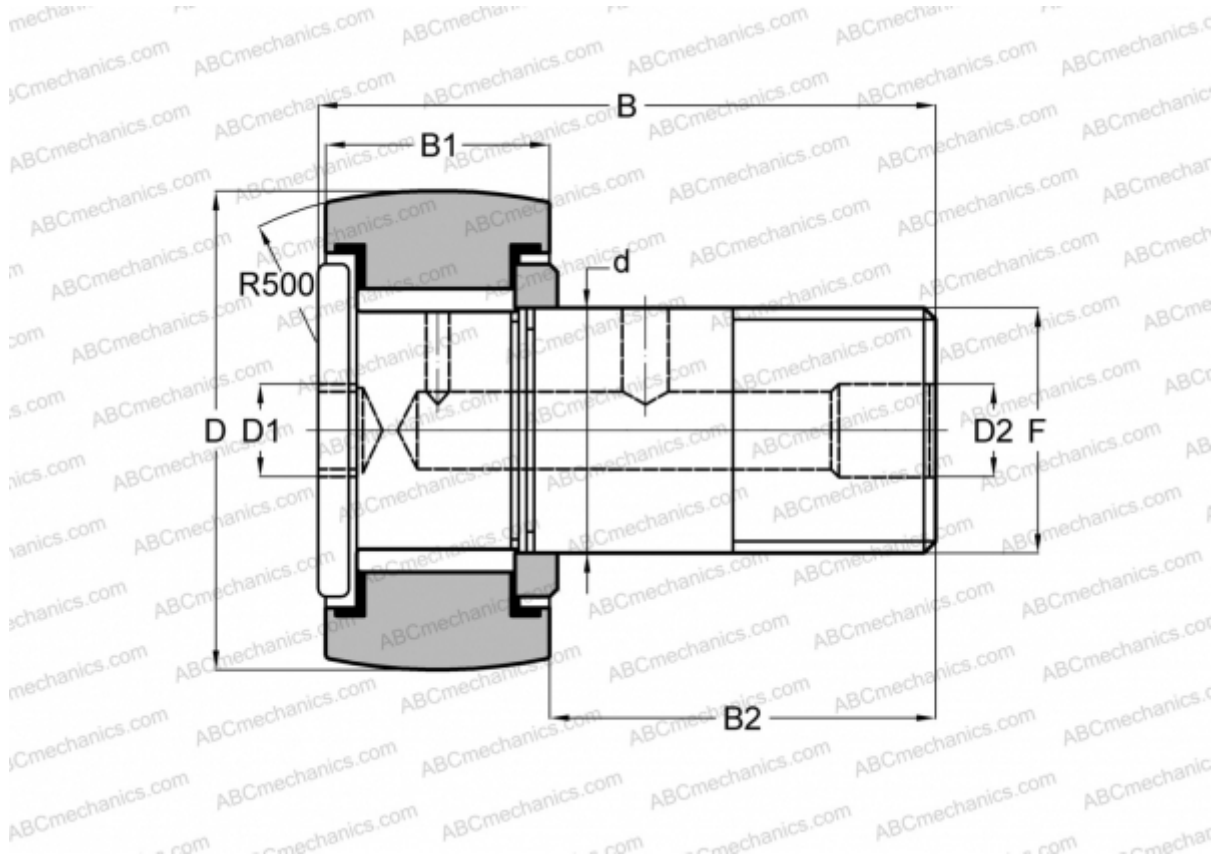

Technical specification

DIMENSIONS, MM

d	25,400
D	44,450
D1	7,938
D2	4,763
B	70,643
B1	25,400
B2	44,450
F	1-14

INTERCHANGE

SMITH BEARING

[HR 1 3/4 XBC](#)

WEIGHT, KG

0,463

MANUFACTURER

[TORRINGTON](#)

INTERCHANGE

McGill

[CCFH 1 3/4 SB](#)

RBC

[CH 56 LW](#)