

CCFH 2 3/4 SB McGill

Cam followers

TYPE: Roller bearings, Stud type track rollers, Heavy duty stud, hex socket, contact seals on both side, inch size

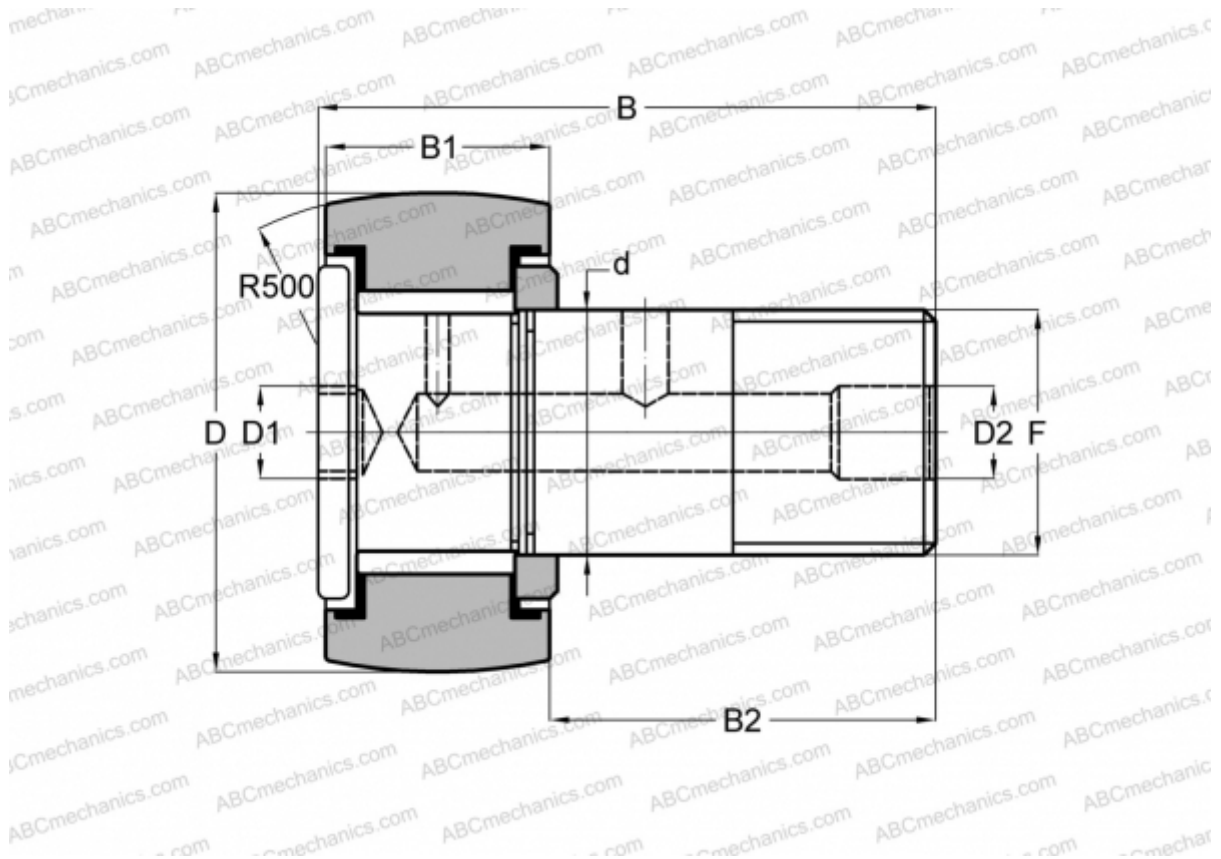

Technical specification

DIMENSIONS, MM

d	31,750
D	69,850
D1	12,700
D2	4,763
B	96,043
B1	38,100
B2	57,150
F	1 1/4-12

INTERCHANGE

SMITH BEARING

[HR 2 3/4 XBC](#)

WEIGHT, KG

1,447

MANUFACTURER

[McGill](#)

INTERCHANGE

TORRINGTON

[CRHSBC 44](#)

RBC

[CH 88 LW](#)