

FCR19R NSK

Cam followers

TYPE: Roller bearings, Stud type track rollers, With axial guidance, full complement bearing, outer ring has a spherical outside surface, type FCR..R (NSK)

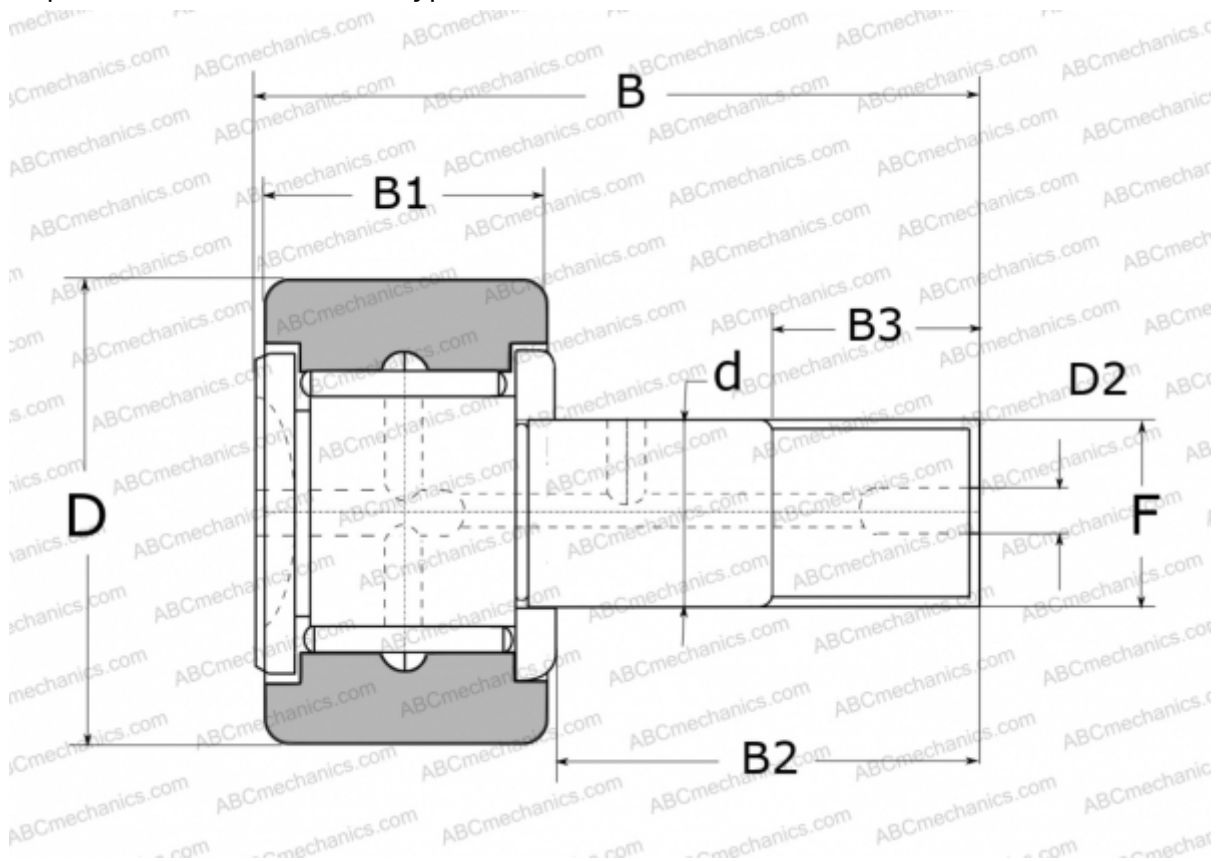

Technical specification

DIMENSIONS, MM

d	8,000
D	19,000
D2	4,000
B	32,000
B1	11,000
B2	20,000
B3	10,000
F	M8X1.25

WEIGHT, KG 0,031

MANUFACTURER [NSK](#)

REPLACES

FCR-19 R