

FCR62R NSK

Cam followers

TYPE: Roller bearings, Stud type track rollers, With axial guidance, full complement bearing, outer ring has a spherical outside surface, type FCR..R (NSK)

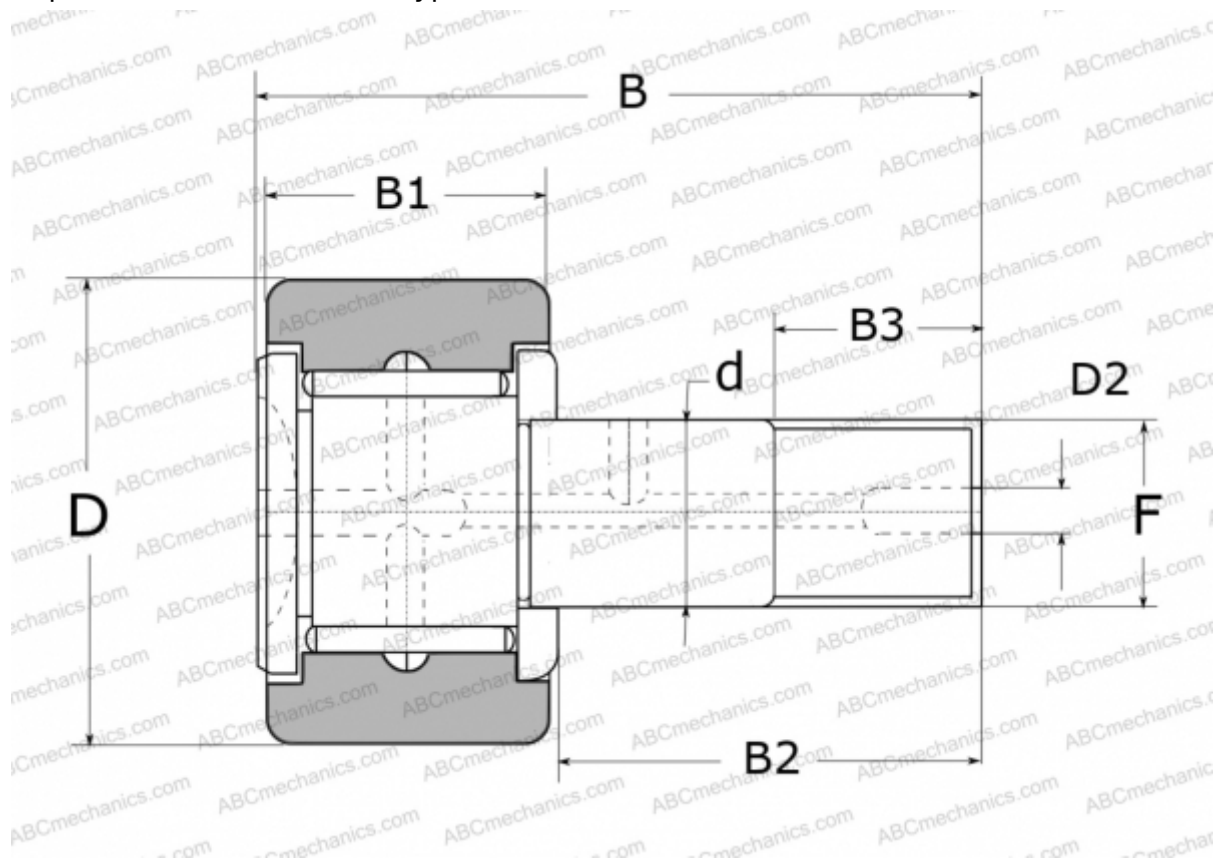

Technical specification

DIMENSIONS, MM

d	24,000
D	62,000
D2	8,000
B	80,000
B1	29,000
B2	49,500
B3	25,000
F	M24X1.5

WEIGHT, KG 0,800

MANUFACTURER [NSK](#)

REPLACES

FCR-62 R