

FCR35 NSK

Cam followers

TYPE: Roller bearings, Stud type track rollers, With axial guidance, full complement bearing, outer ring has a cylindrical outside surface, type FCR (NSK)

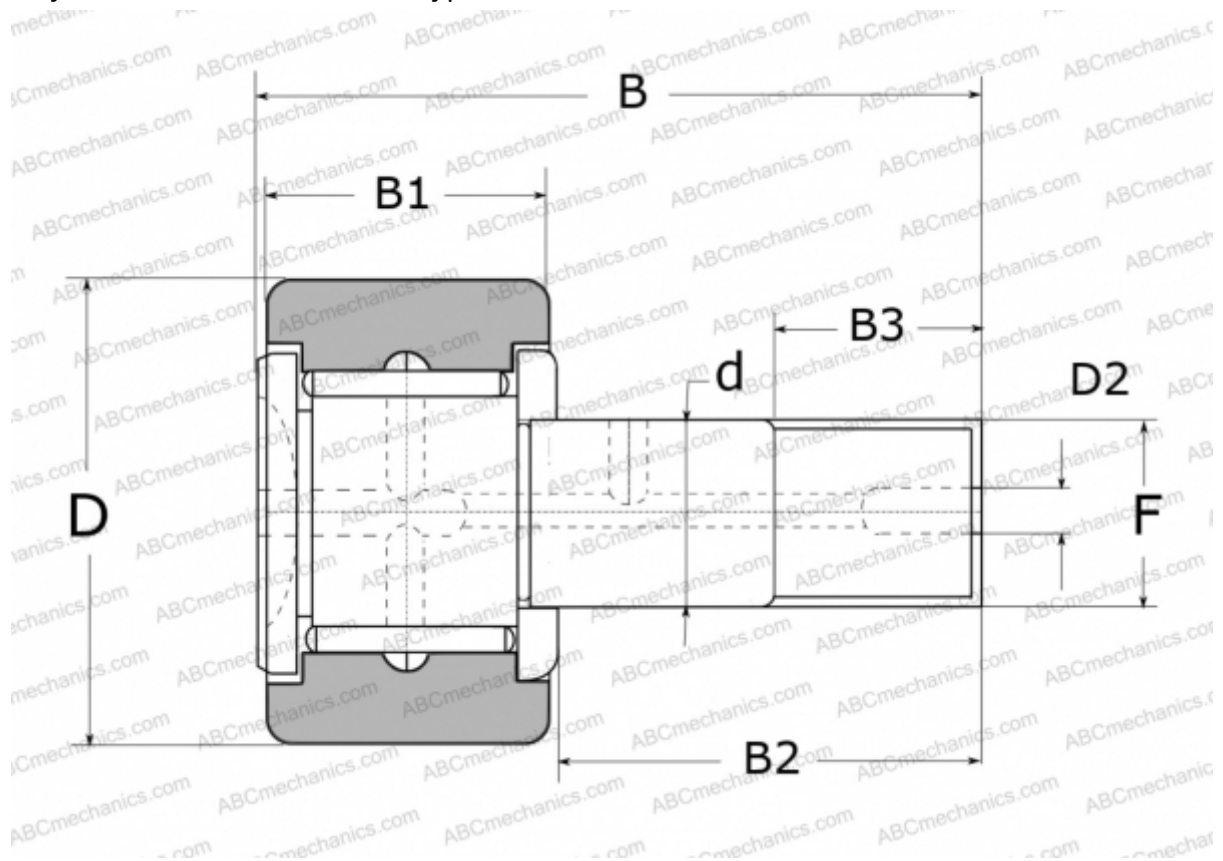

Technical specification

DIMENSIONS, MM

d	16,000
D	35,000
D2	6,000
B	52,000
B1	18,000
B2	32,500
B3	17,000
F	M16X1.5

WEIGHT, KG 0,170

MANUFACTURER [NSK](#)

REPLACES

FCR-35