

FCR52 NSK

Cam followers

TYPE: Roller bearings, Stud type track rollers, With axial guidance, full complement bearing, outer ring has a cylindrical outside surface, type FCR (NSK)

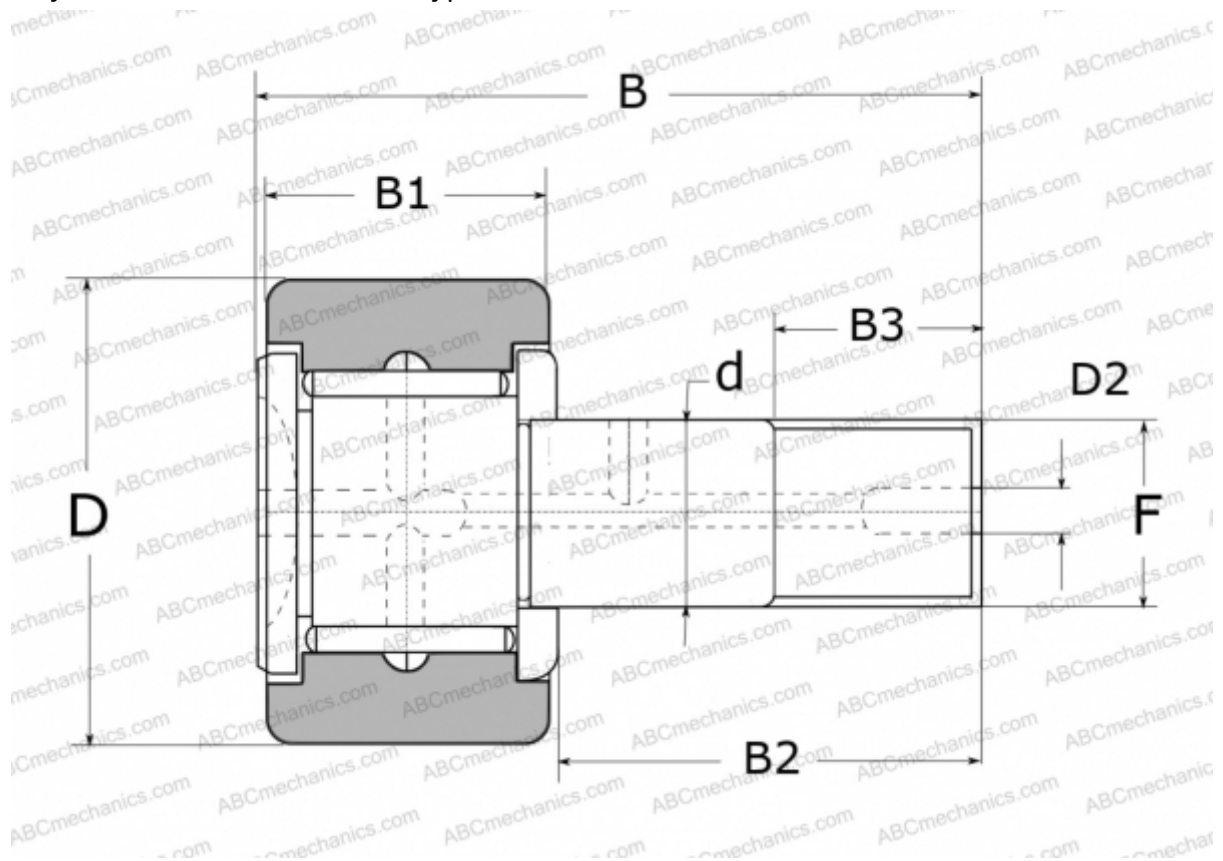

Technical specification

DIMENSIONS, MM

d	20,000
D	52,000
D2	8,000
B	66,000
B1	24,000
B2	40,500
B3	21,000
F	M20X1.5

WEIGHT, KG 0,470

MANUFACTURER [NSK](#)

REPLACES

FCR-52