

## FCR72 NSK

Cam followers

TYPE: Roller bearings, Stud type track rollers, With axial guidance, full complement bearing, outer ring has a cylindrical outside surface, type FCR (NSK)

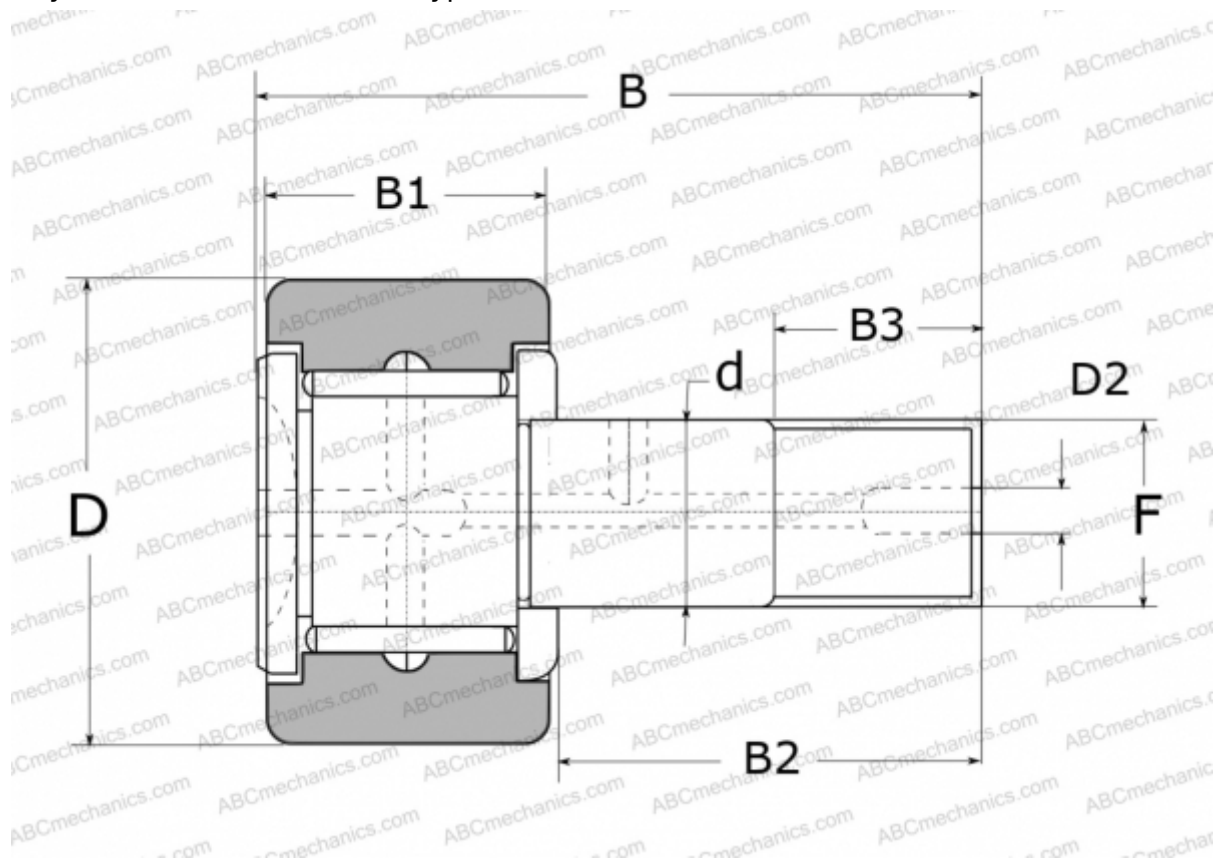

### Technical specification

#### DIMENSIONS, MM

d	24,000
D	72,000
D2	8,000
B	80,000
B1	29,000
B2	49,500
B3	25,000
F	M24X1.5

**WEIGHT, KG** 1,050

**MANUFACTURER** [NSK](#)

#### REPLACES

FCR-72