

FCJ72R NSK

Cam followers

TYPE: Roller bearings, Stud type track rollers, With axial guidance, with cage, outer ring has a spherical outside surface, type FCJ..R (NSK)

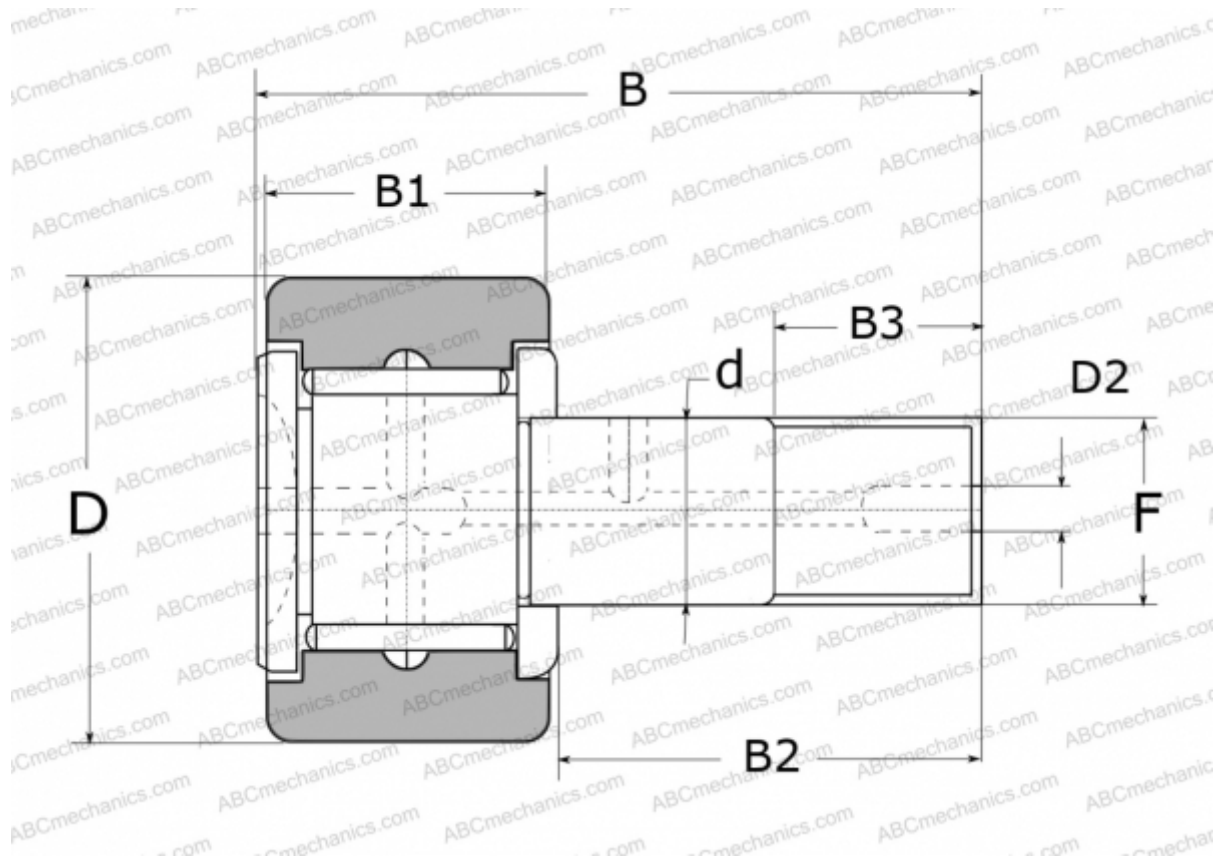

Technical specification

DIMENSIONS, MM

d	24,000
D	72,000
D2	8,000
B	80,000
B1	29,000
B2	49,500
B3	25,000
F	M24X1.5

WEIGHT, KG 1,050

MANUFACTURER [NSK](#)

REPLACES

FCJ-72 R