

FCJ16 NSK

Cam followers

TYPE: Roller bearings, Stud type track rollers, With axial guidance, with cage, outer ring has a cylindrical outside surface, type FCJ (NSK)

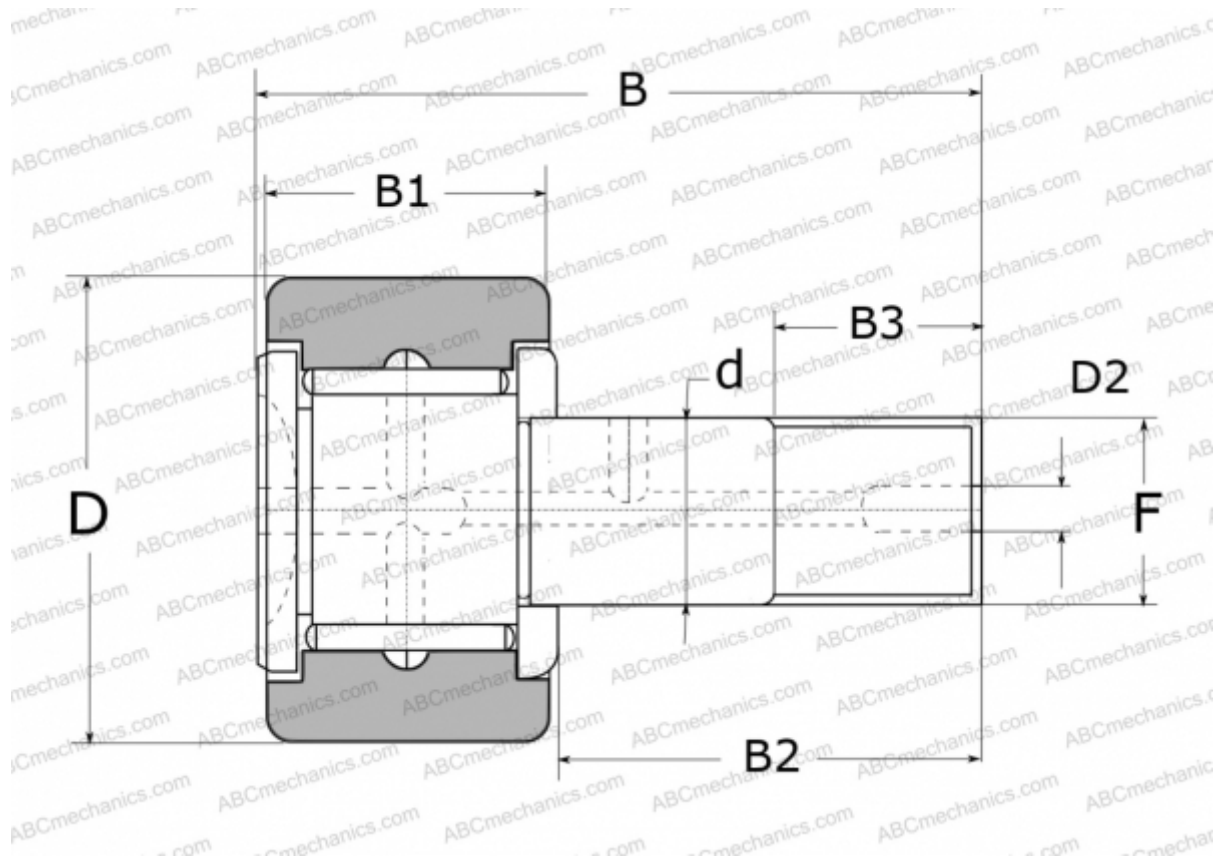

Technical specification

DIMENSIONS, MM

d	6,000
D	16,000
D2	4,000
B	28,000
B1	11,000
B2	16,000
B3	8,000
F	M6X1.0

WEIGHT, KG 0,018

MANUFACTURER [NSK](#)

REPLACES

FCJ-16