

FCJ26 NSK

Cam followers

TYPE: Roller bearings, Stud type track rollers, With axial guidance, with cage, outer ring has a cylindrical outside surface, type FCJ (NSK)

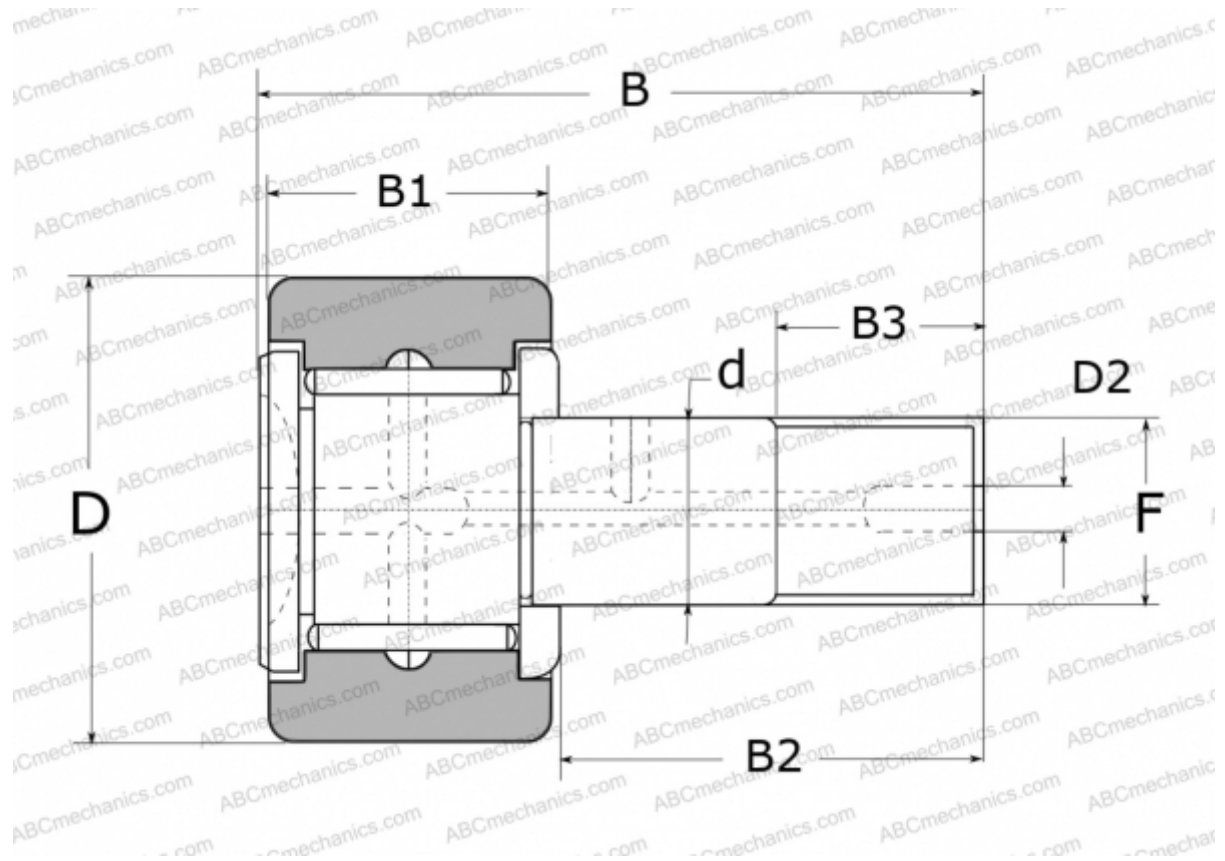

Technical specification

DIMENSIONS, MM

d	10,000
D	26,000
D2	4,000
B	36,000
B1	12,000
B2	23,000
B3	12,000
F	M10X1.25

WEIGHT, KG 0,058

MANUFACTURER [NSK](#)

REPLACES

FCJ-26