

FCJ30 NSK

Cam followers

TYPE: Roller bearings, Stud type track rollers, With axial guidance, with cage, outer ring has a cylindrical outside surface, type FCJ (NSK)

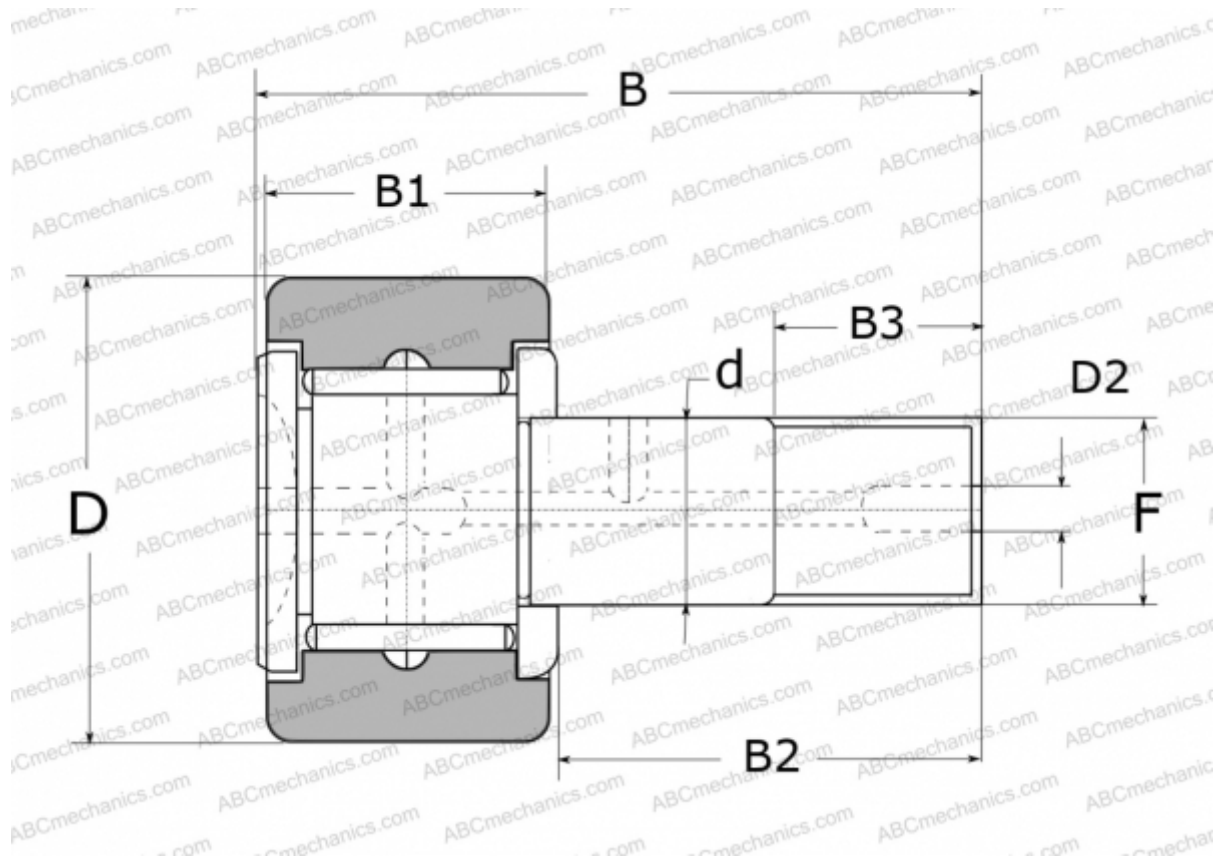

Technical specification

DIMENSIONS, MM

d	12,000
D	30,000
D2	6,000
B	40,000
B1	14,000
B2	25,000
B3	13,000
F	M12X1.5

WEIGHT, KG 0,086

MANUFACTURER [NSK](#)

REPLACES

FCJ-30