

## FCJ35 NSK

Cam followers

TYPE: Roller bearings, Stud type track rollers, With axial guidance, with cage, outer ring has a cylindrical outside surface, type FCJ (NSK)

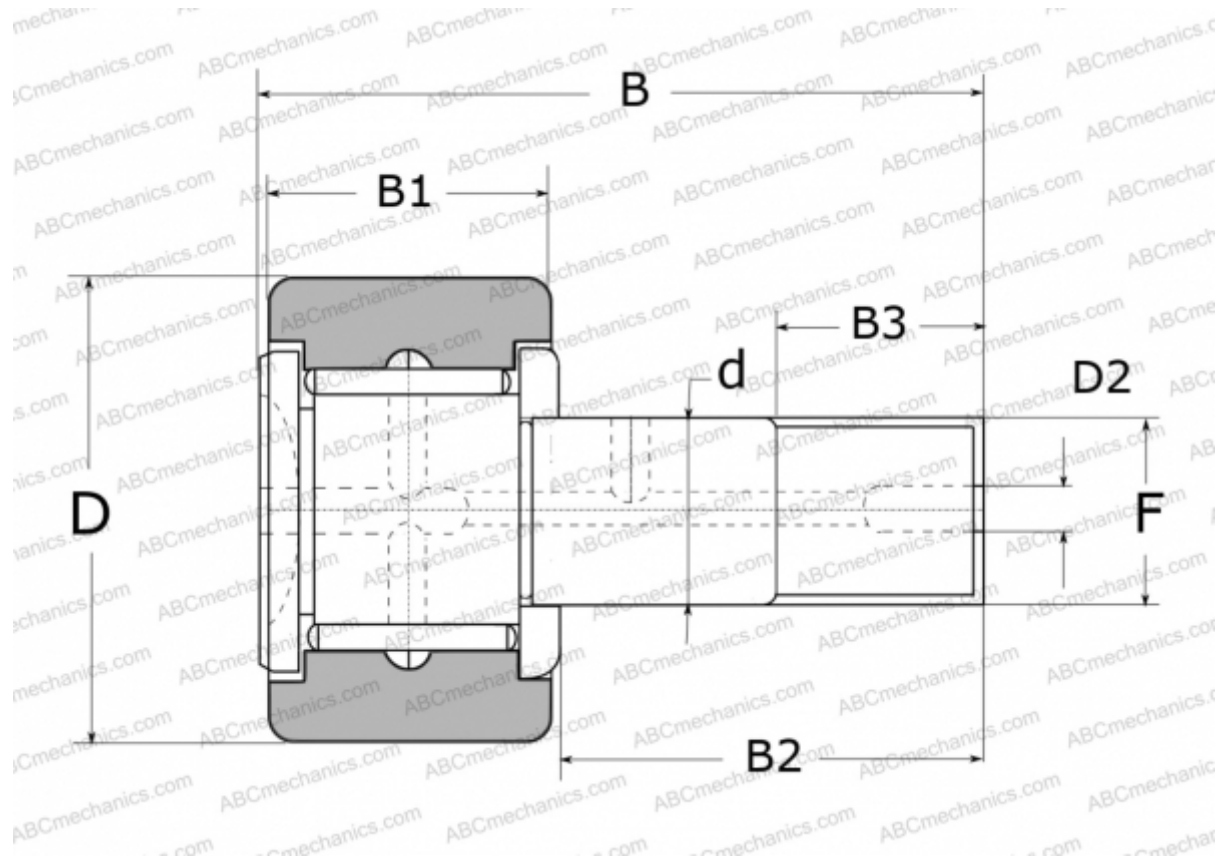

### Technical specification

#### DIMENSIONS, MM

d	16,000
D	35,000
D2	6,000
B	52,000
B1	18,000
B2	32,500
B3	17,000
F	M16X1.5

**WEIGHT, KG** 0,165

**MANUFACTURER** [NSK](#)

#### REPLACES

FCJ-35