

## FCJ47 NSK

Cam followers

TYPE: Roller bearings, Stud type track rollers, With axial guidance, with cage, outer ring has a cylindrical outside surface, type FCJ (NSK)

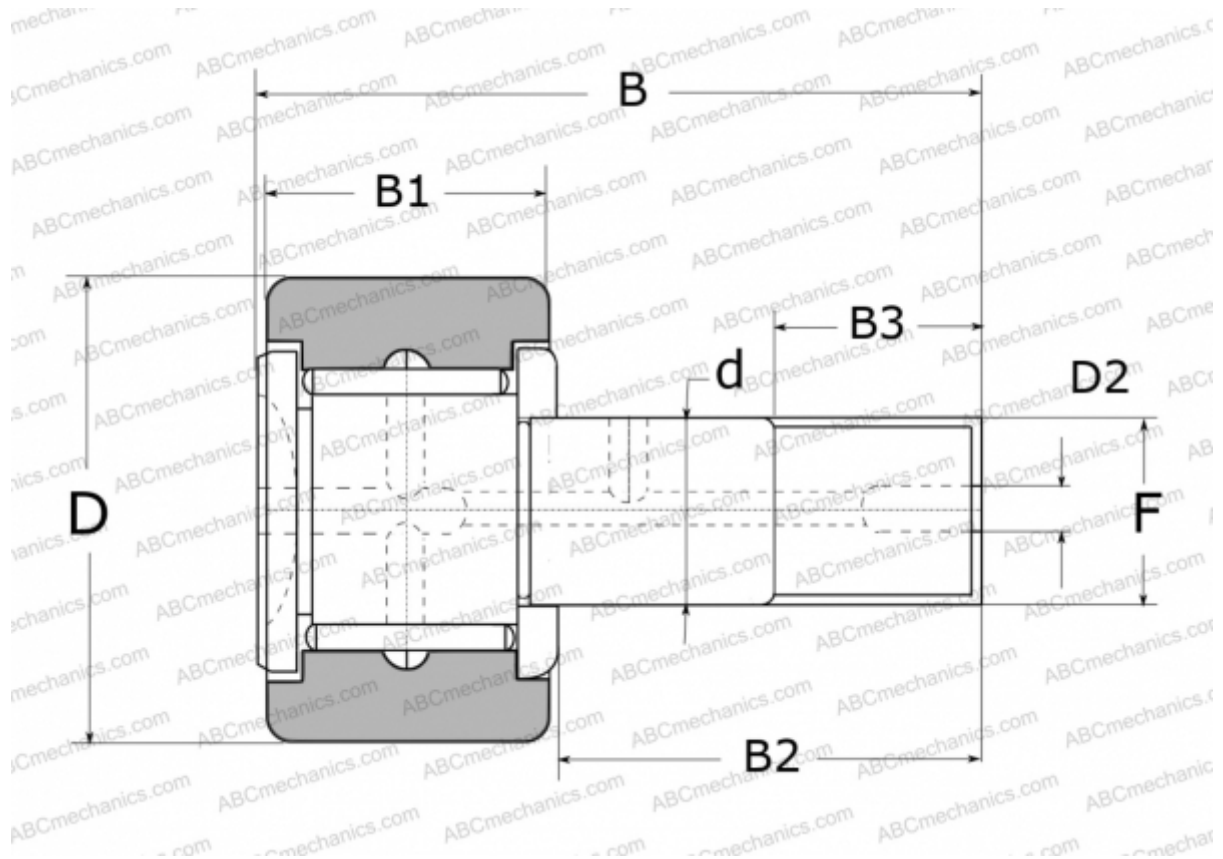

### Technical specification

#### DIMENSIONS, MM

d	20,000
D	47,000
D2	8,000
B	66,000
B1	24,000
B2	40,500
B3	21,000
F	M20X1.5

**WEIGHT, KG** 0,380

**MANUFACTURER** [NSK](#)

#### REPLACES

FCJ-47