

FCJ80 NSK

Cam followers

TYPE: Roller bearings, Stud type track rollers, With axial guidance, with cage, outer ring has a cylindrical outside surface, type FCJ (NSK)

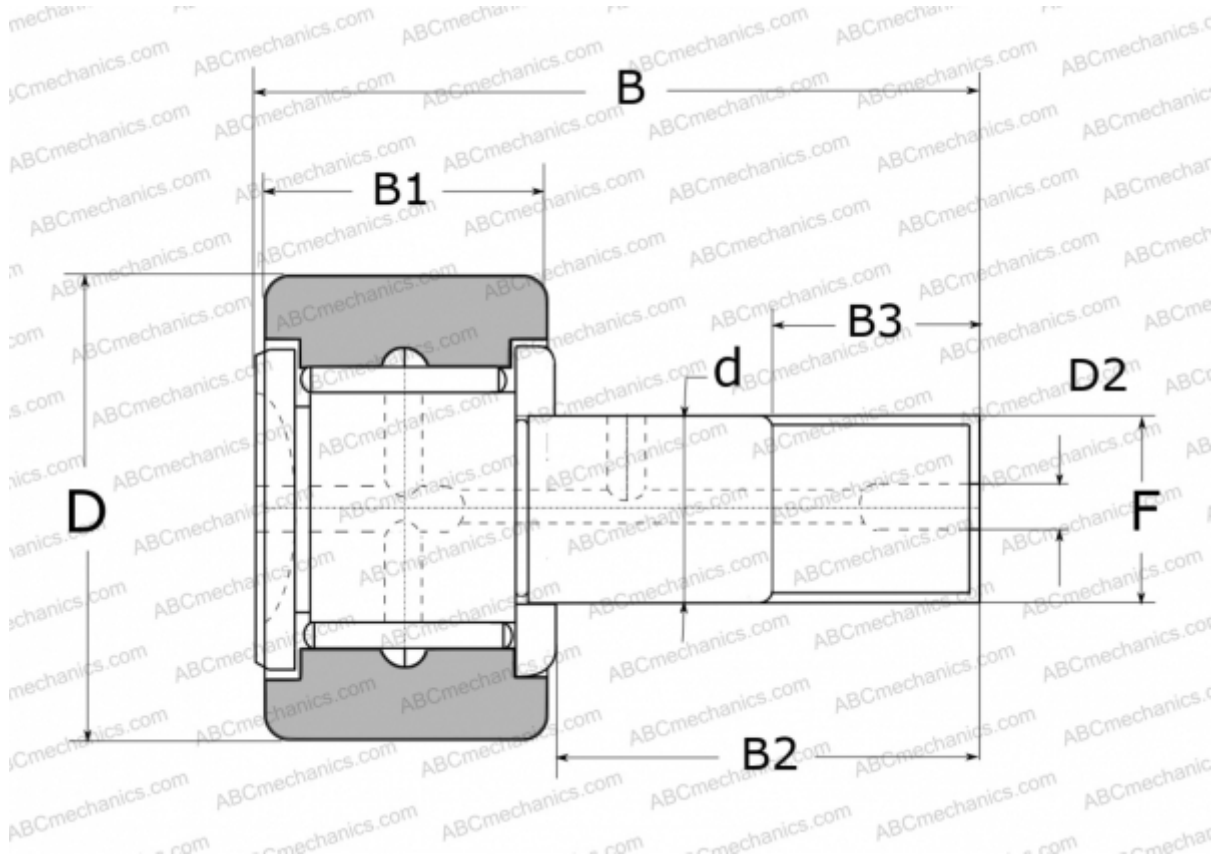

Technical specification

DIMENSIONS, MM

d	30,000
D	80,000
D2	8,000
B	100,000
B1	35,000
B2	63,000
B3	32,000
F	M30X1.5

WEIGHT, KG 1,550

MANUFACTURER [NSK](#)

REPLACES

FCJ-80