

FCJS19R NSK

Cam followers

TYPE: Roller bearings, Stud type track rollers, With axial guidance, with cage, with seal, with thrust washer, outer ring has a spherical outside surface, type FCJS..R (NSK)

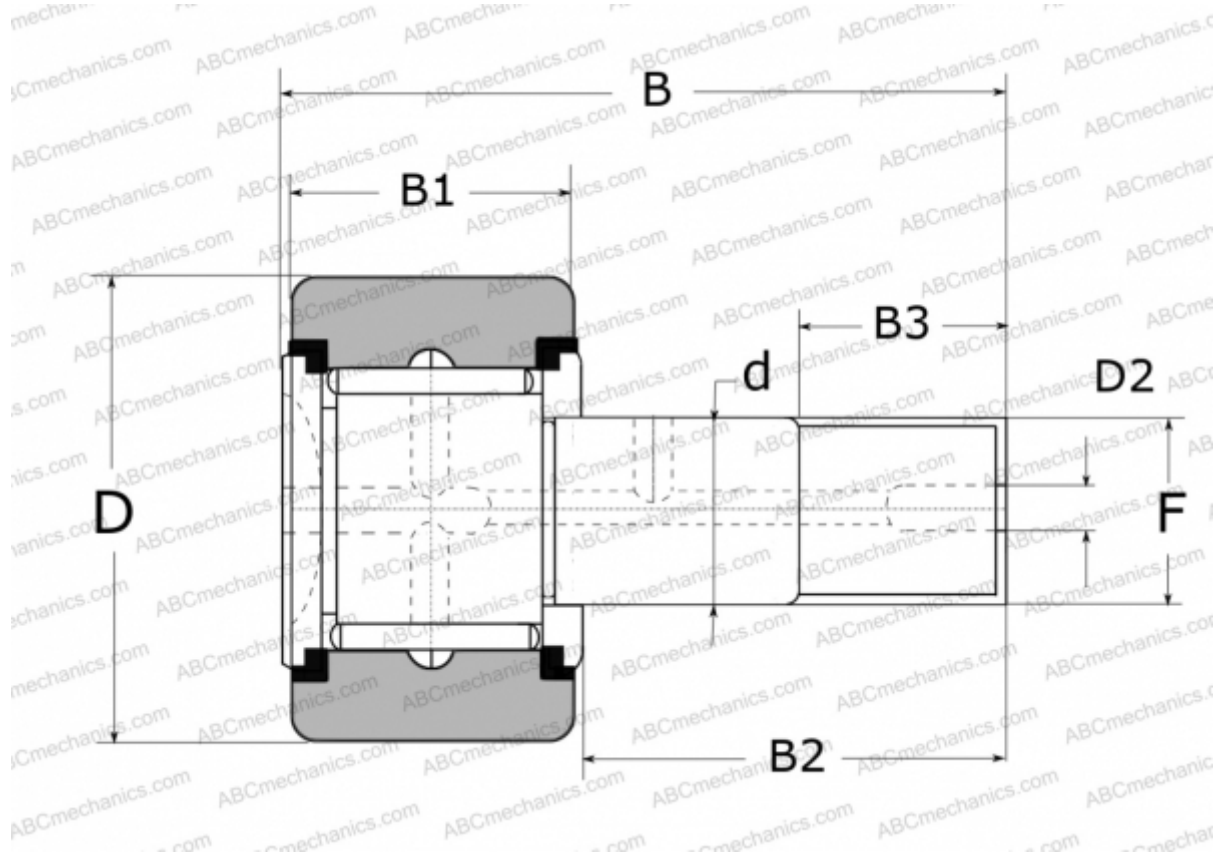

Technical specification

DIMENSIONS, MM

d	8,000
D	19,000
D2	4,000
B	32,000
B1	11,000
B2	20,000
B3	10,000
F	M8X1.25

WEIGHT, KG 0,030

MANUFACTURER [NSK](#)

REPLACES

FCJS-19 R