

## FCJS16 NSK

Cam followers

TYPE: Roller bearings, Stud type track rollers, With axial guidance, with cage, with seal, with thrust washer, outer ring has a cylindrical outside surface, type FCJS (NSK)

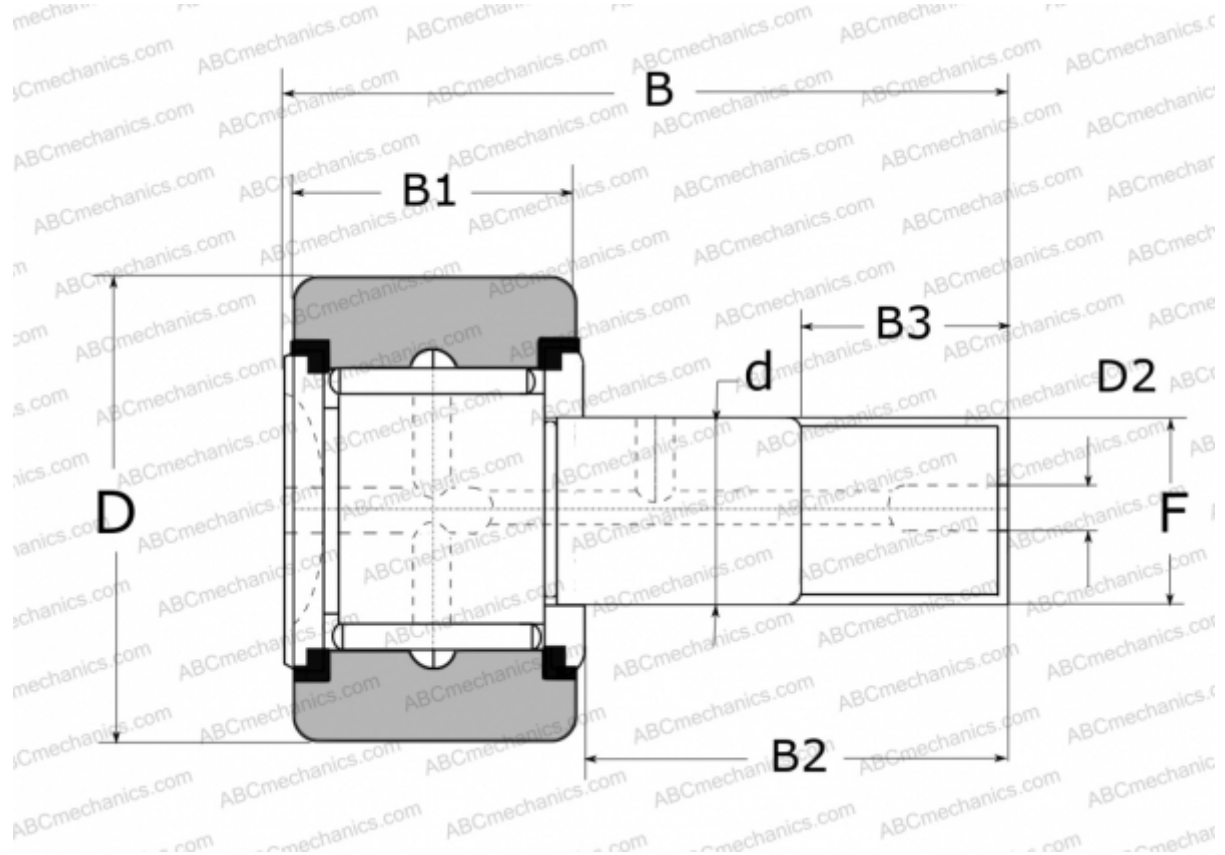

### Technical specification

#### DIMENSIONS, MM

d	6,000
D	16,000
D2	4,000
B	28,000
B1	11,000
B2	16,000
B3	8,000
F	M6X1.0

**WEIGHT, KG** 0,018

**MANUFACTURER** [NSK](#)

#### REPLACES

FCJS-16