

FCJS40 NSK

Cam followers

TYPE: Roller bearings, Stud type track rollers, With axial guidance, with cage, with seal, with thrust washer, outer ring has a cylindrical outside surface, type FCJS (NSK)

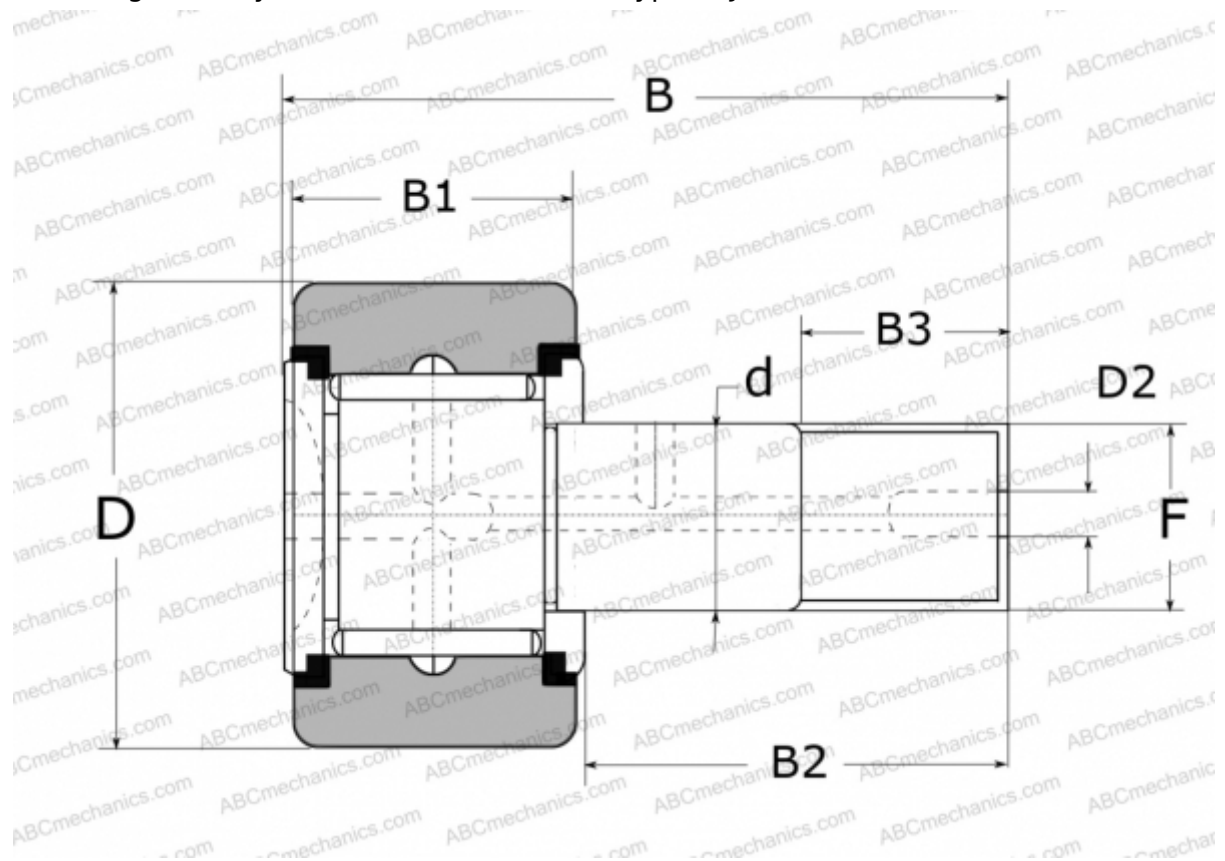

Technical specification

DIMENSIONS, MM

d	18,000
D	40,000
D2	6,000
B	58,000
B1	20,000
B2	36,500
B3	19,000
F	M18X1.5

WEIGHT, KG 0,240

MANUFACTURER [NSK](#)

REPLACES

FCJS-40