

FCJS47 NSK

Cam followers

TYPE: Roller bearings, Stud type track rollers, With axial guidance, with cage, with seal, with thrust washer, outer ring has a cylindrical outside surface, type FCJS (NSK)

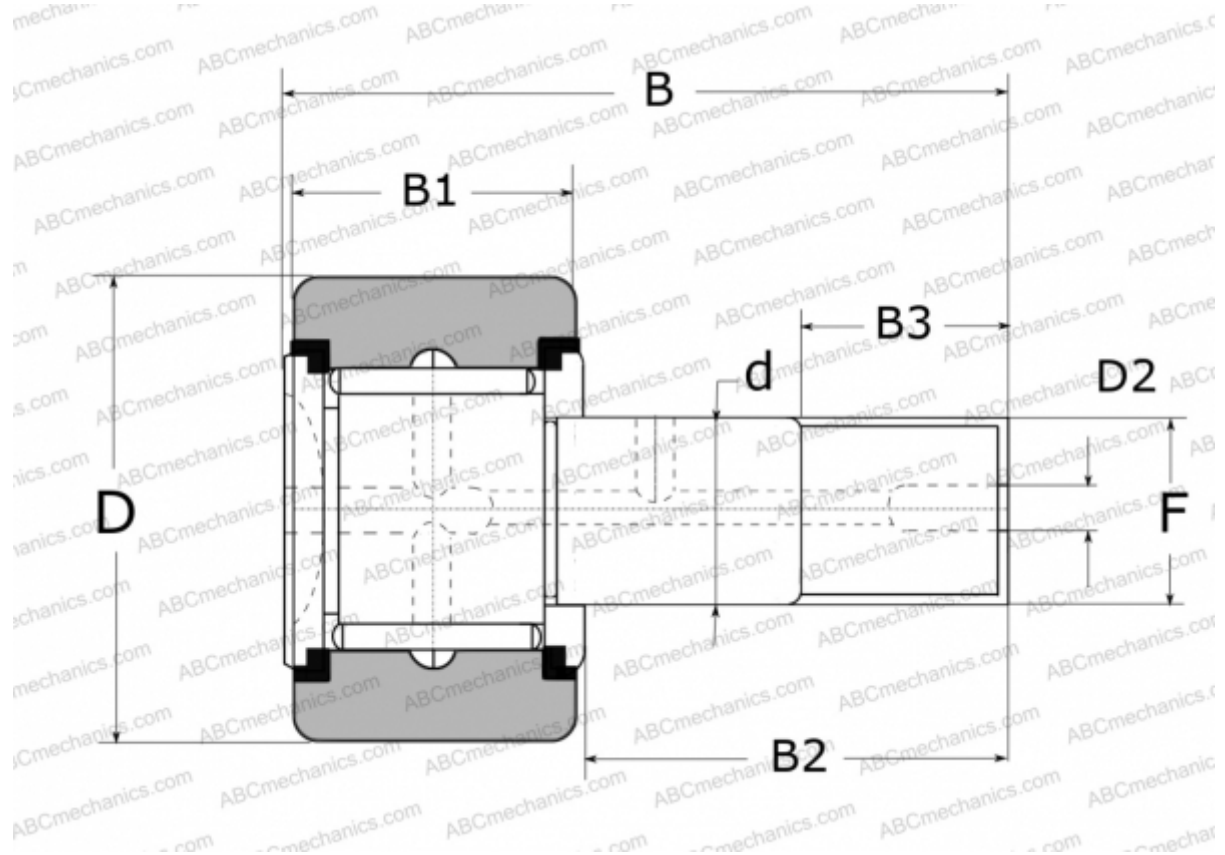

Technical specification

DIMENSIONS, MM

d	20,000
D	47,000
D2	8,000
B	66,000
B1	24,000
B2	40,500
B3	21,000
F	M20X1.5

WEIGHT, KG 0,380

MANUFACTURER [NSK](#)

REPLACES

FCJS-47