

CR12R NSK

Cam followers

TYPE: Roller bearings, Stud type track rollers, With axial guidance, full complement bearing, outer ring has a spherical outside surface, type CR..R (NSK), inch size

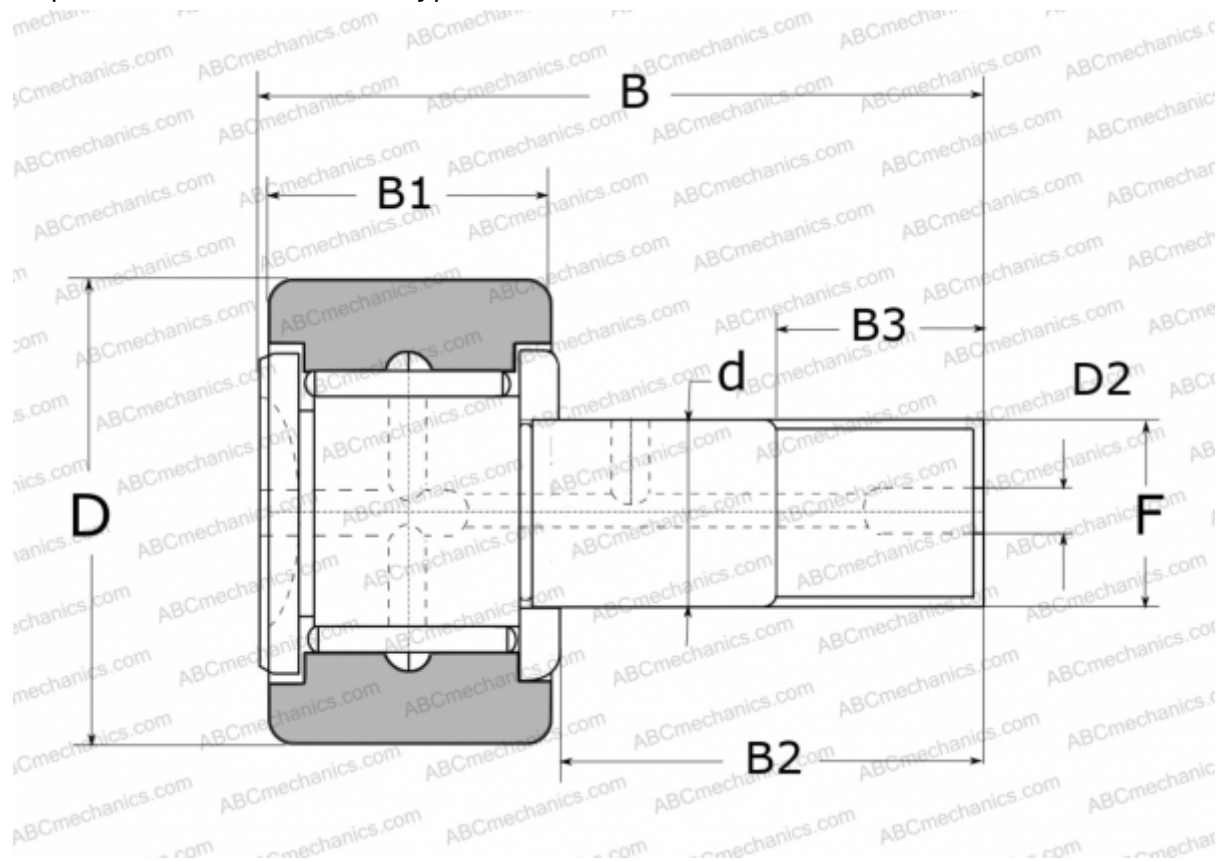

Technical specification

DIMENSIONS, MM

d	9,525
D	19,050
D2	4,800
B	36,100
B1	12,700
B2	22,220
B3	9,500
F	3/8-24

WEIGHT, KG 0,034

MANUFACTURER [NSK](#)

REPLACES

CR-12 R