

CR36R NSK

Cam followers

TYPE: Roller bearings, Stud type track rollers, With axial guidance, full complement bearing, outer ring has a spherical outside surface, type CR..R (NSK), inch size

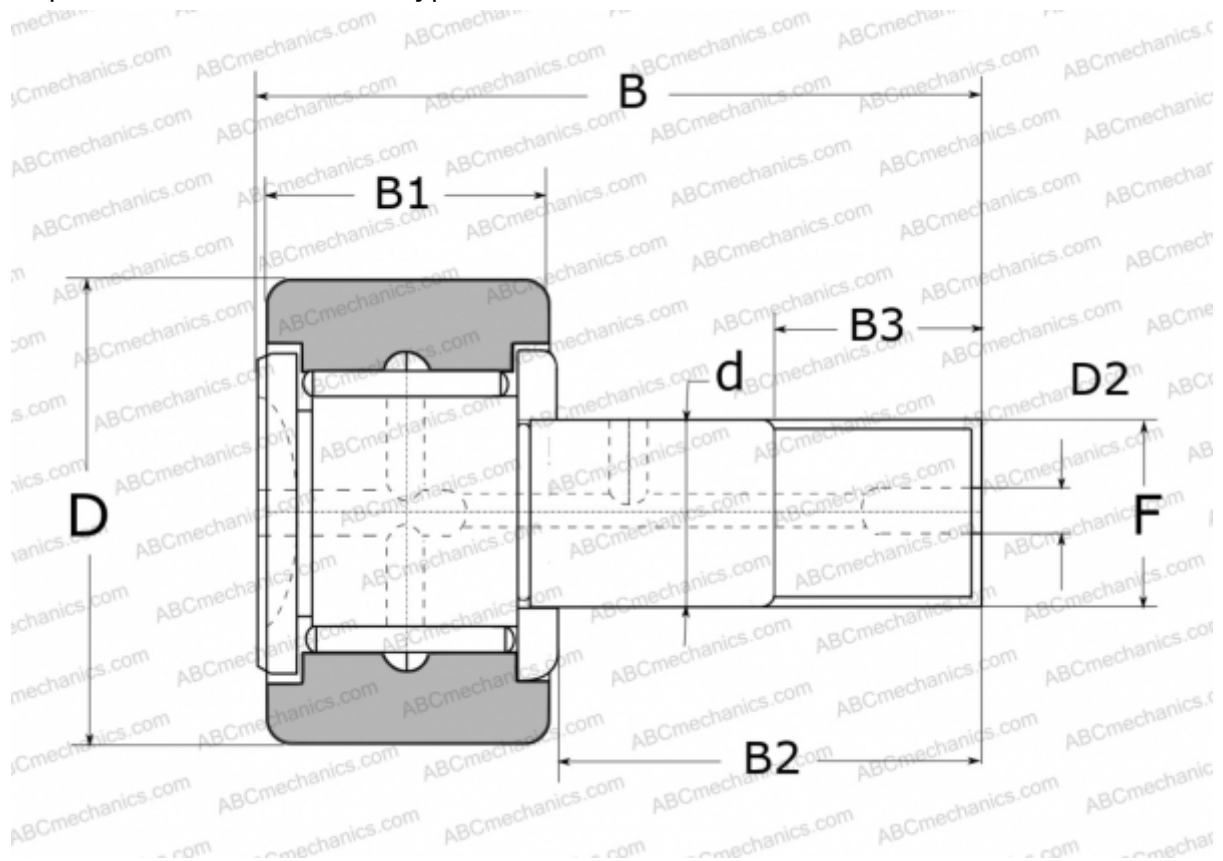

Technical specification

DIMENSIONS, MM

d	22,225
D	57,150
D2	4,800
B	83,900
B1	31,750
B2	50,800
B3	25,400
F	7/8-14

WEIGHT, KG 0,755

MANUFACTURER [NSK](#)

REPLACES

CR-36 R