

CR10 NSK

Cam followers

TYPE: Roller bearings, Stud type track rollers, With axial guidance, full complement bearing, outer ring has a cylindrical outside surface, type CR (NSK), inch size

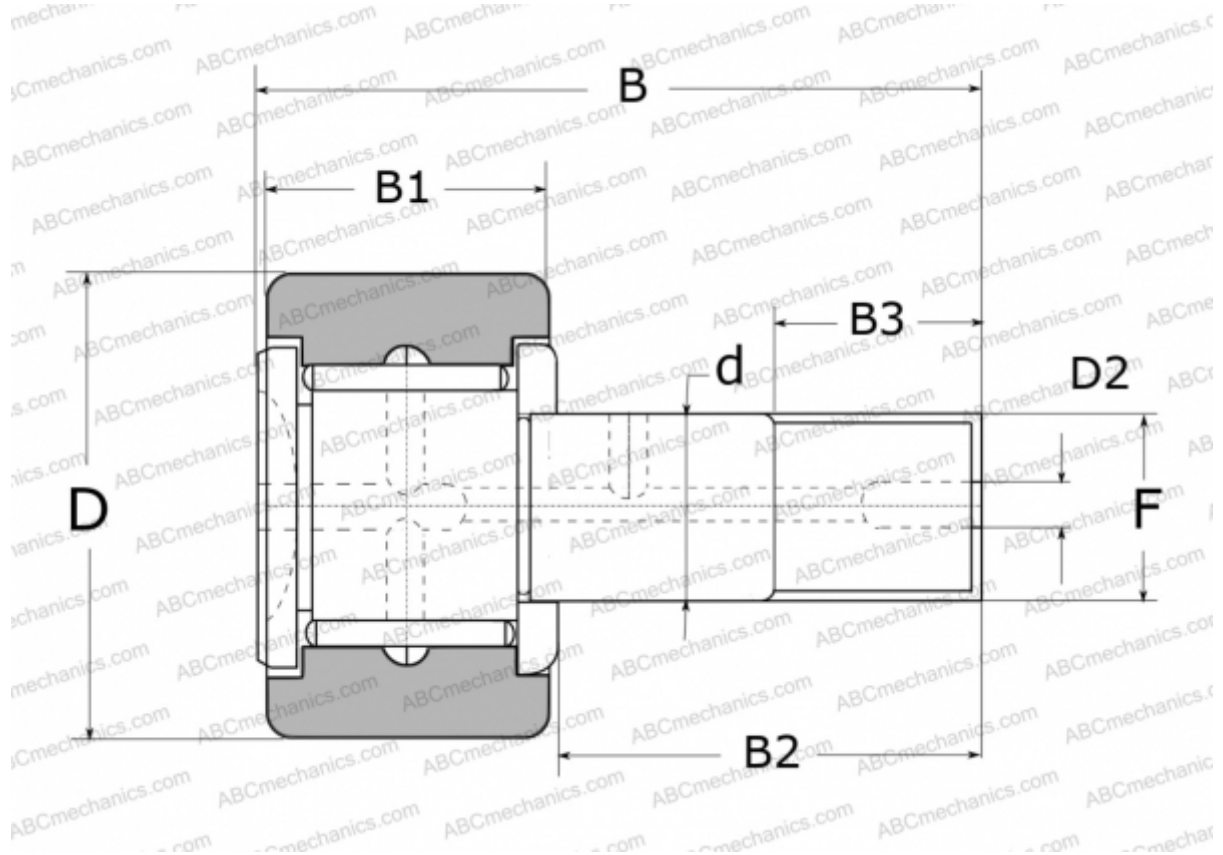

Technical specification

DIMENSIONS, MM

d	6,350
D	15,875
D2	3,200
B	27,300
B1	10,310
B2	15,880
B3	7,900
F	1/4-28

WEIGHT, KG 0,019

MANUFACTURER [NSK](#)

REPLACES

CR-10