

CR30 NSK

Cam followers

TYPE: Roller bearings, Stud type track rollers, With axial guidance, full complement bearing, outer ring has a cylindrical outside surface, type CR (NSK), inch size

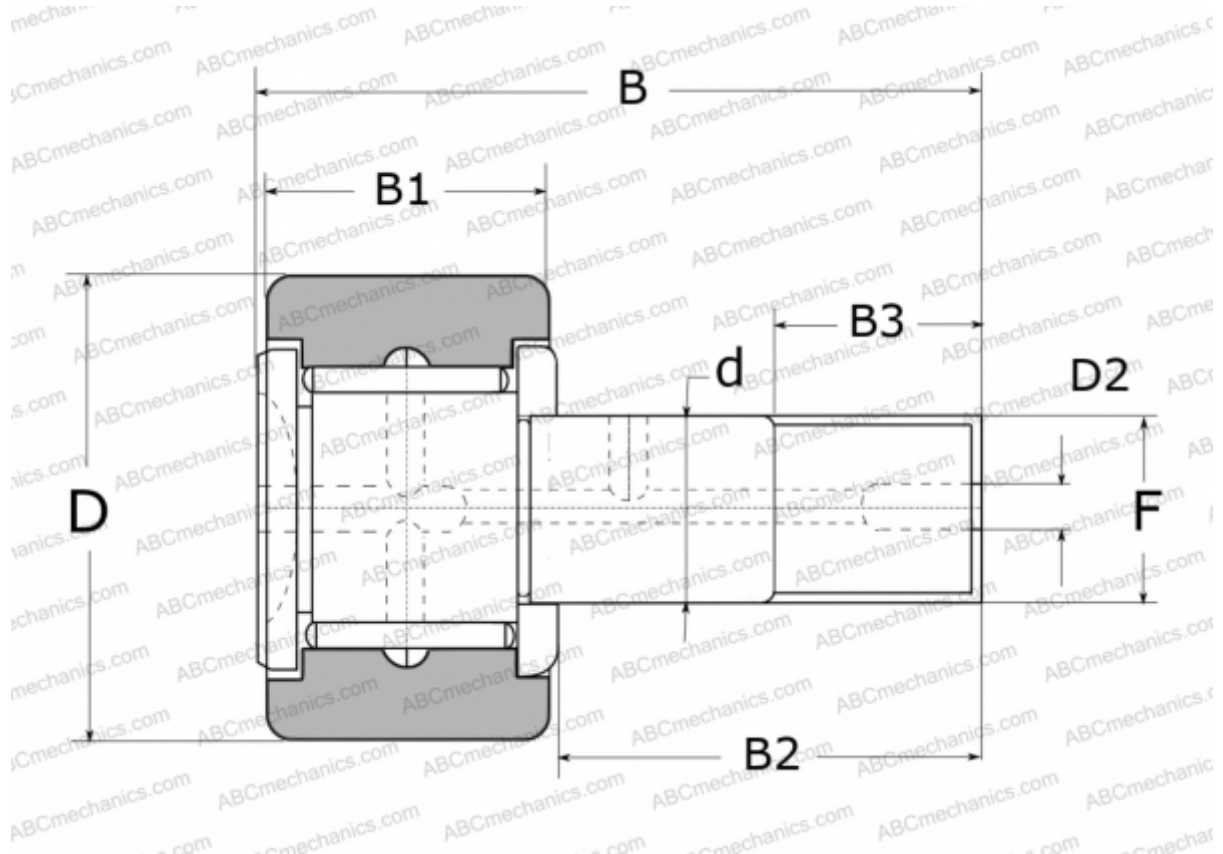

Technical specification

DIMENSIONS, MM

d	19,050
D	47,625
D2	4,800
B	71,200
B1	25,400
B2	44,450
B3	22,200
F	3/4-16

WEIGHT, KG 0,430

MANUFACTURER [NSK](#)

REPLACES

CR-30