

CR32 NSK

Cam followers

TYPE: Roller bearings, Stud type track rollers, With axial guidance, full complement bearing, outer ring has a cylindrical outside surface, type CR (NSK), inch size

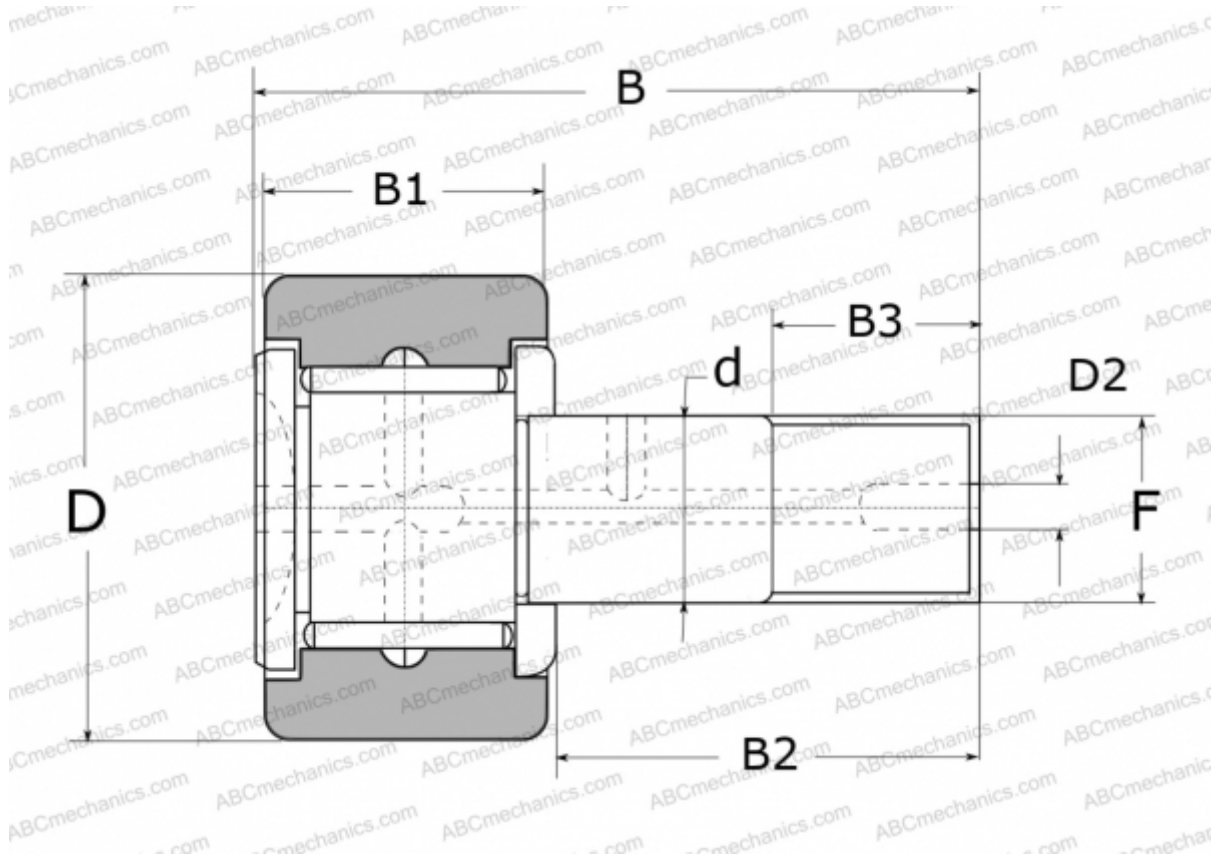

Technical specification

DIMENSIONS, MM

d	22,225
D	50,800
D2	4,800
B	83,900
B1	31,750
B2	50,800
B3	25,400
F	7/8-14

WEIGHT, KG 0,620

MANUFACTURER [NSK](#)

REPLACES

CR-32